

PRINT TILING TEMPLATE GUIDE FOR SIZE SPECIFIC CHOICE
TRIMLESS PRINT AT HOME PATTERN

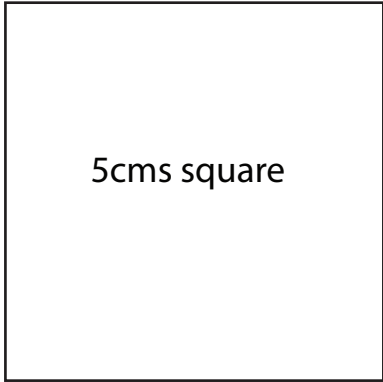

5cms square

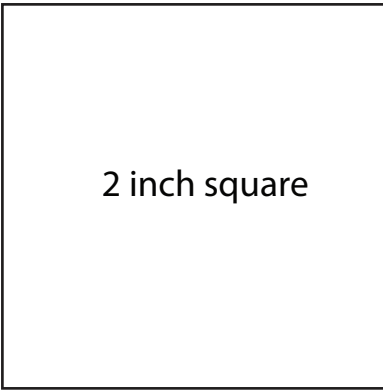

2 inch square

BRIELLE JUMPSUIT

#0223

2

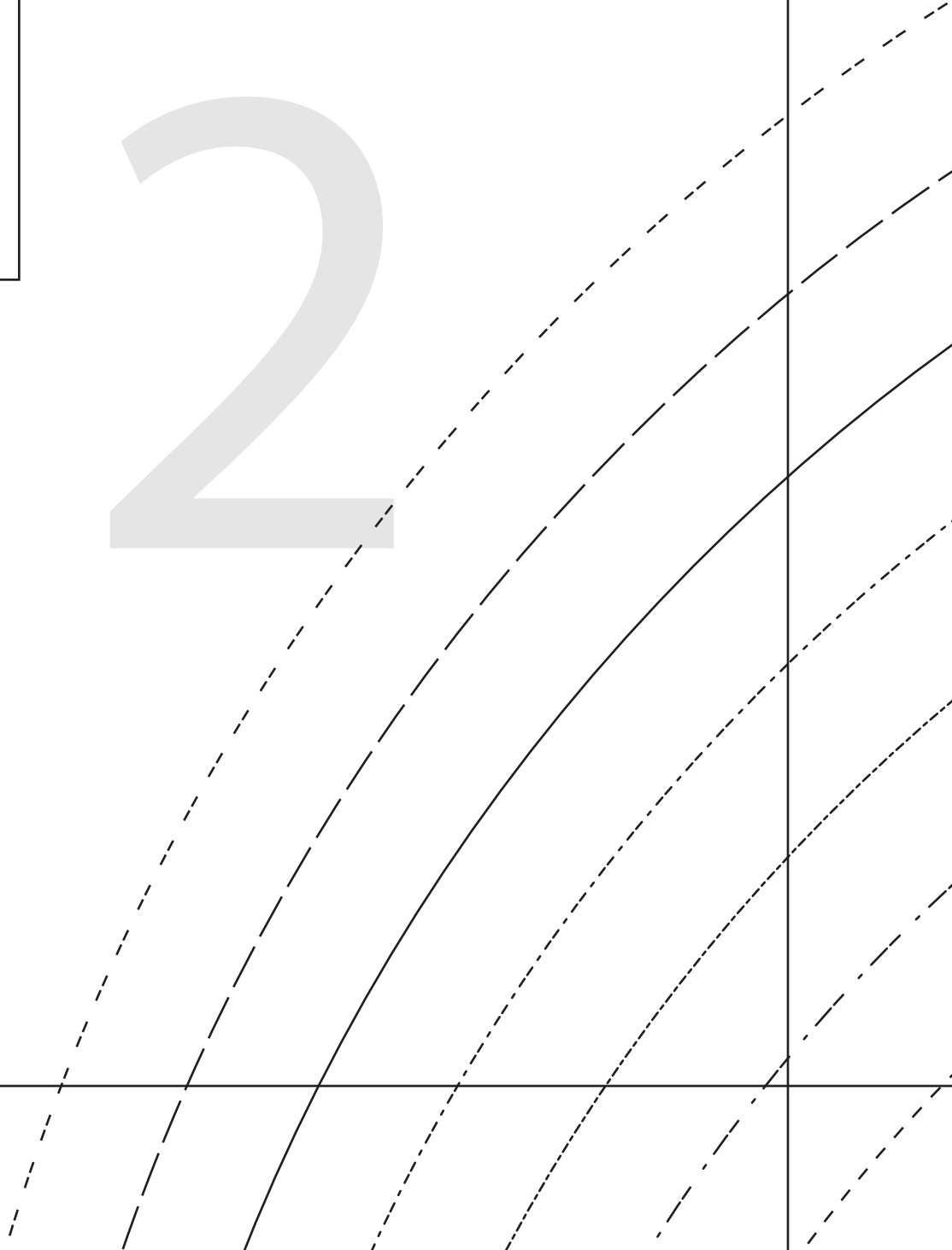

3

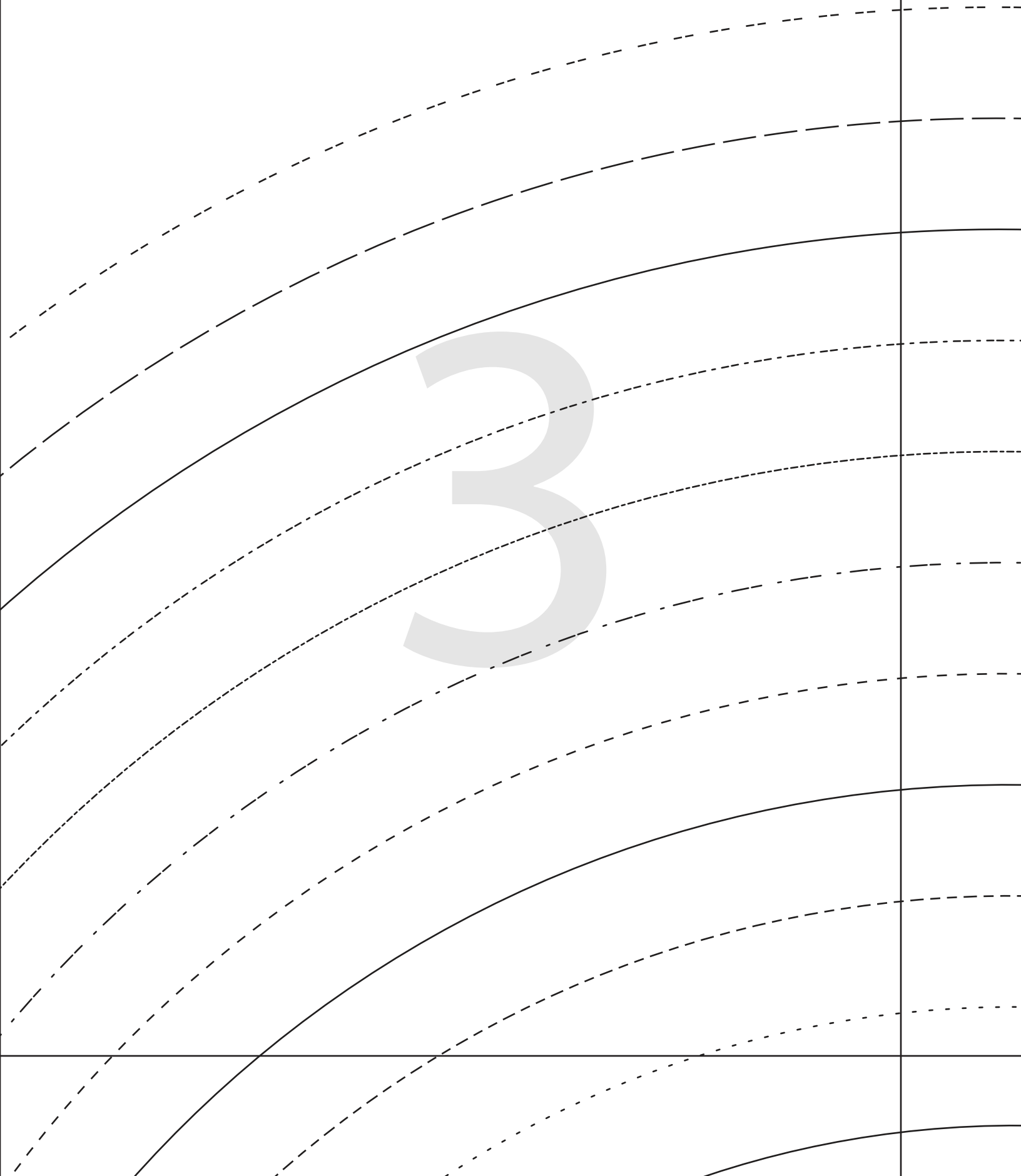

4

5

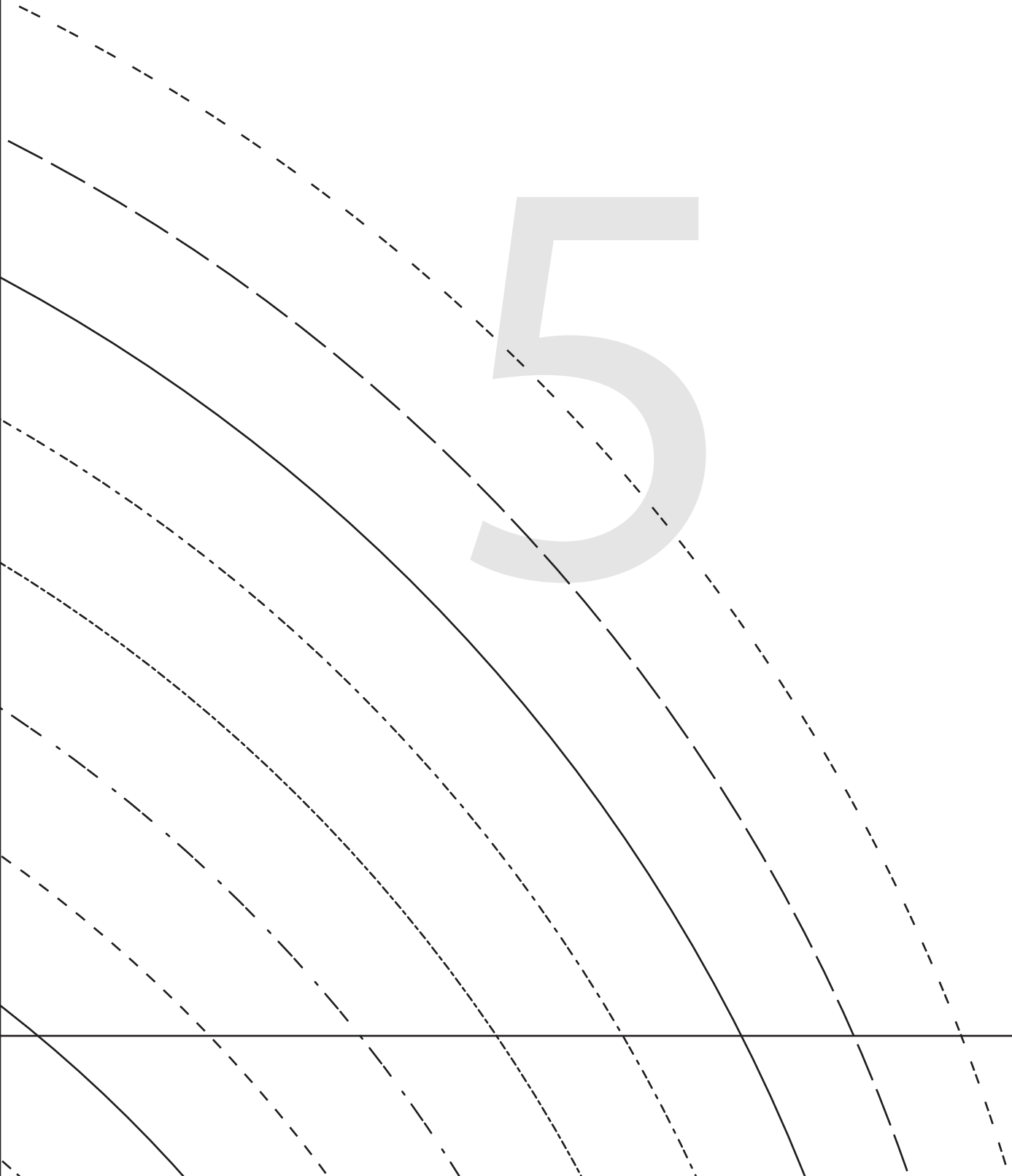

6

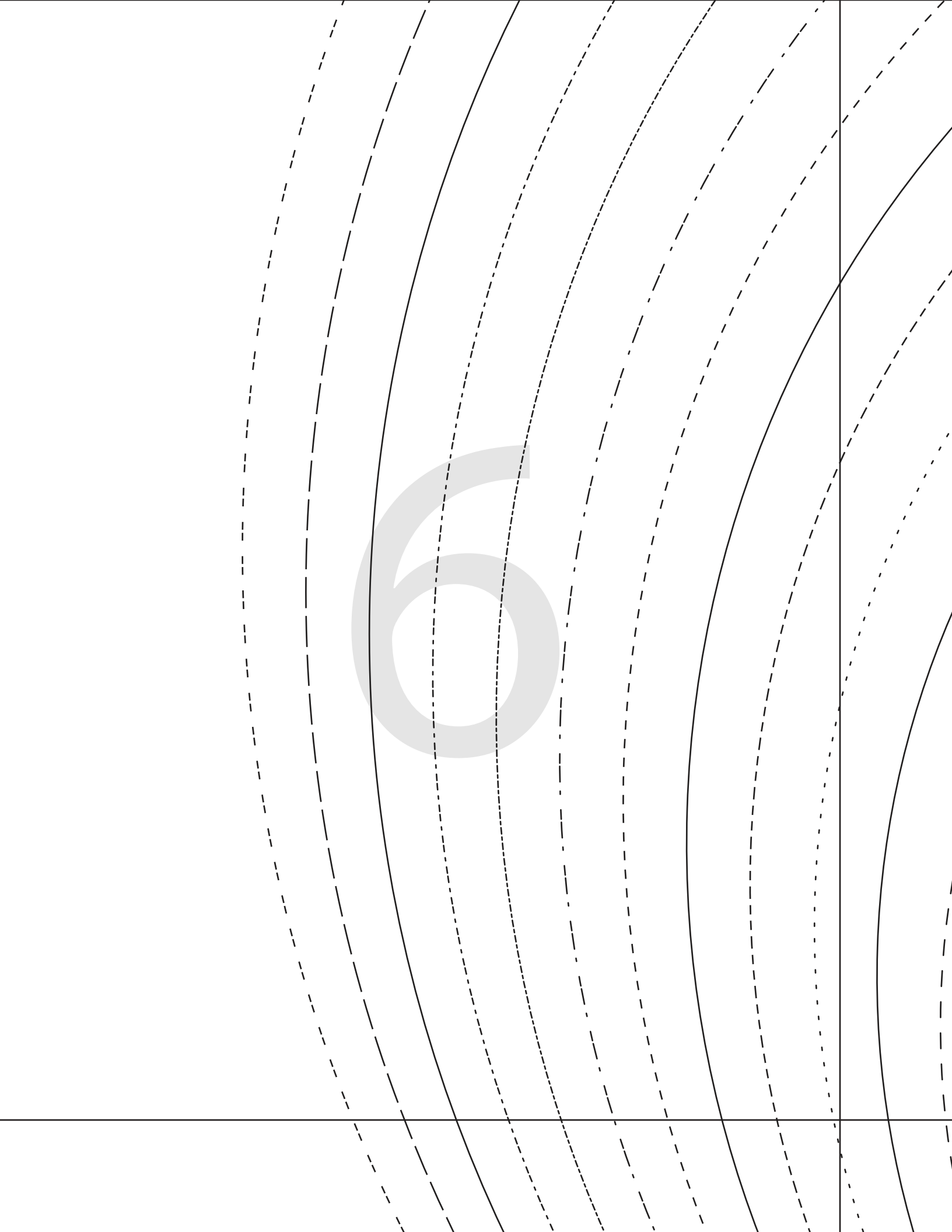



BRIELLE JUMPSUIT
#0223

12

SHORT CIRCLE SLEEVE
CUT 2

(6mms (1/4") seam allowance unless otherwise stated)

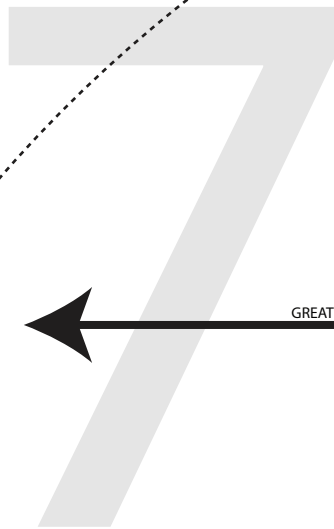



UMPSUIT
23

2
CLE SLEEVE
2
(once unless otherwise stated)

8

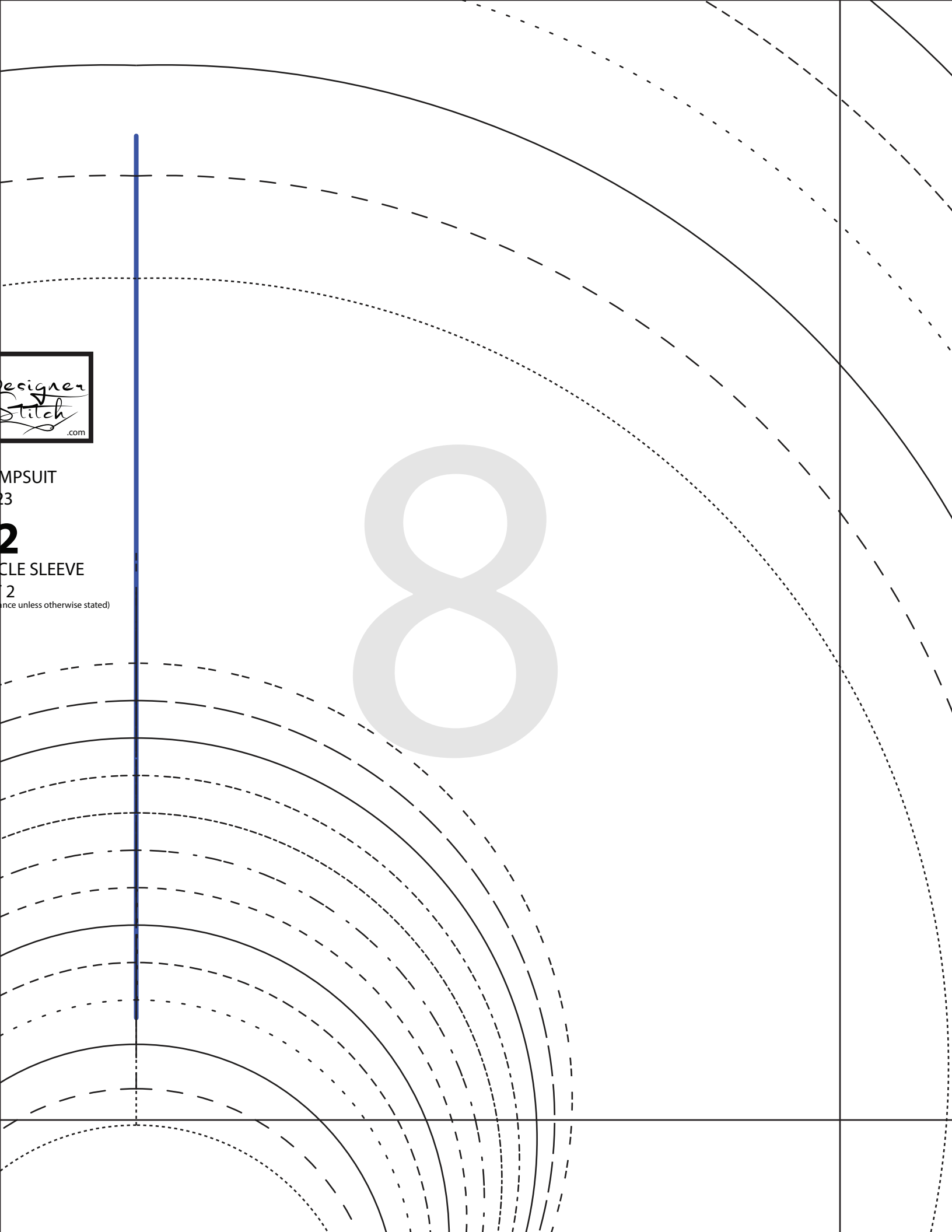

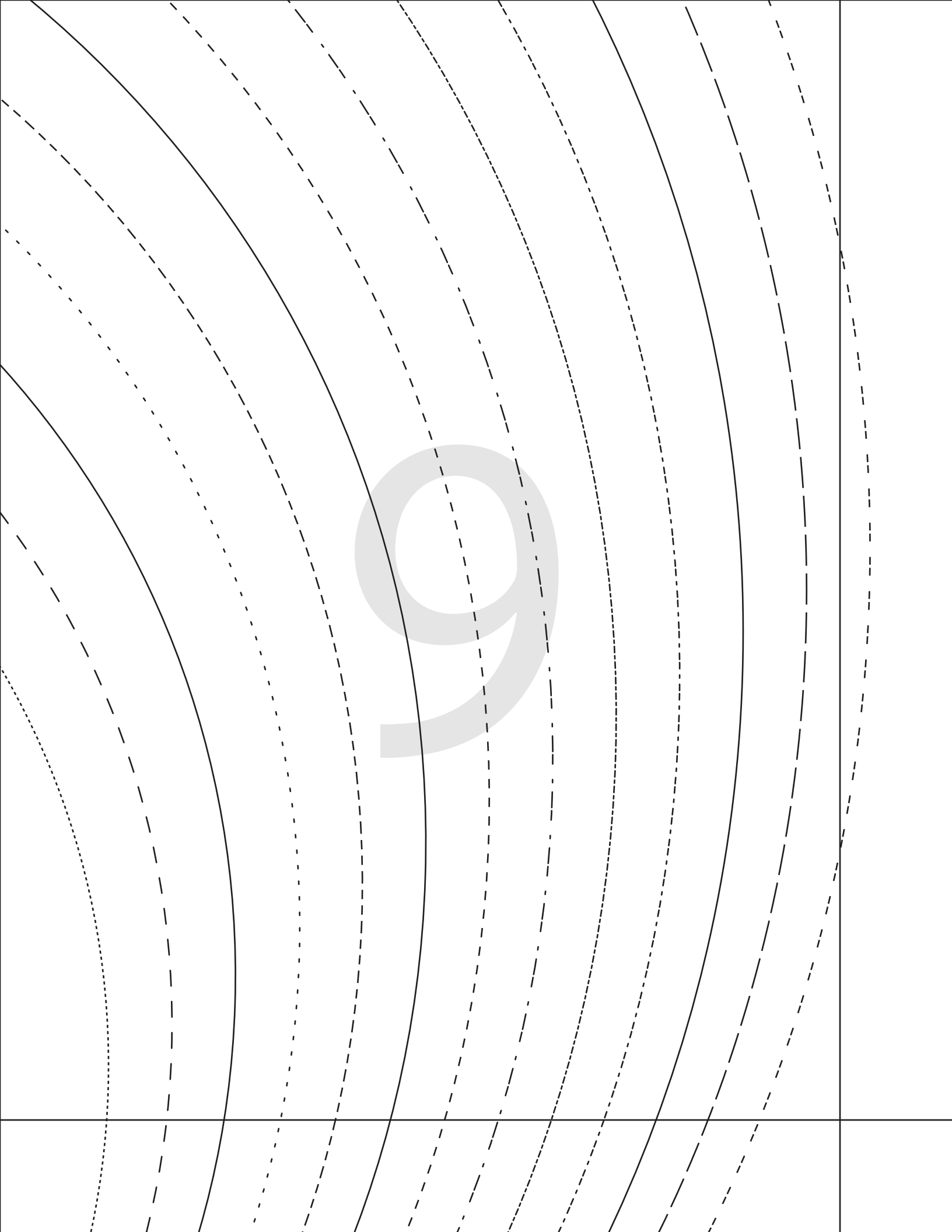

SIZE KEY

1
.....

2 - - - - -
.....

3 _____
.....

4 - - - - -
.....

5 - - - - -
.....

6 - - - - -
.....

7 - - - - -
.....

8 - - - - -
.....

9
.....

10 - - - - -
.....

11 _____
.....

12 - - - - -
.....

13 - - - - -
.....

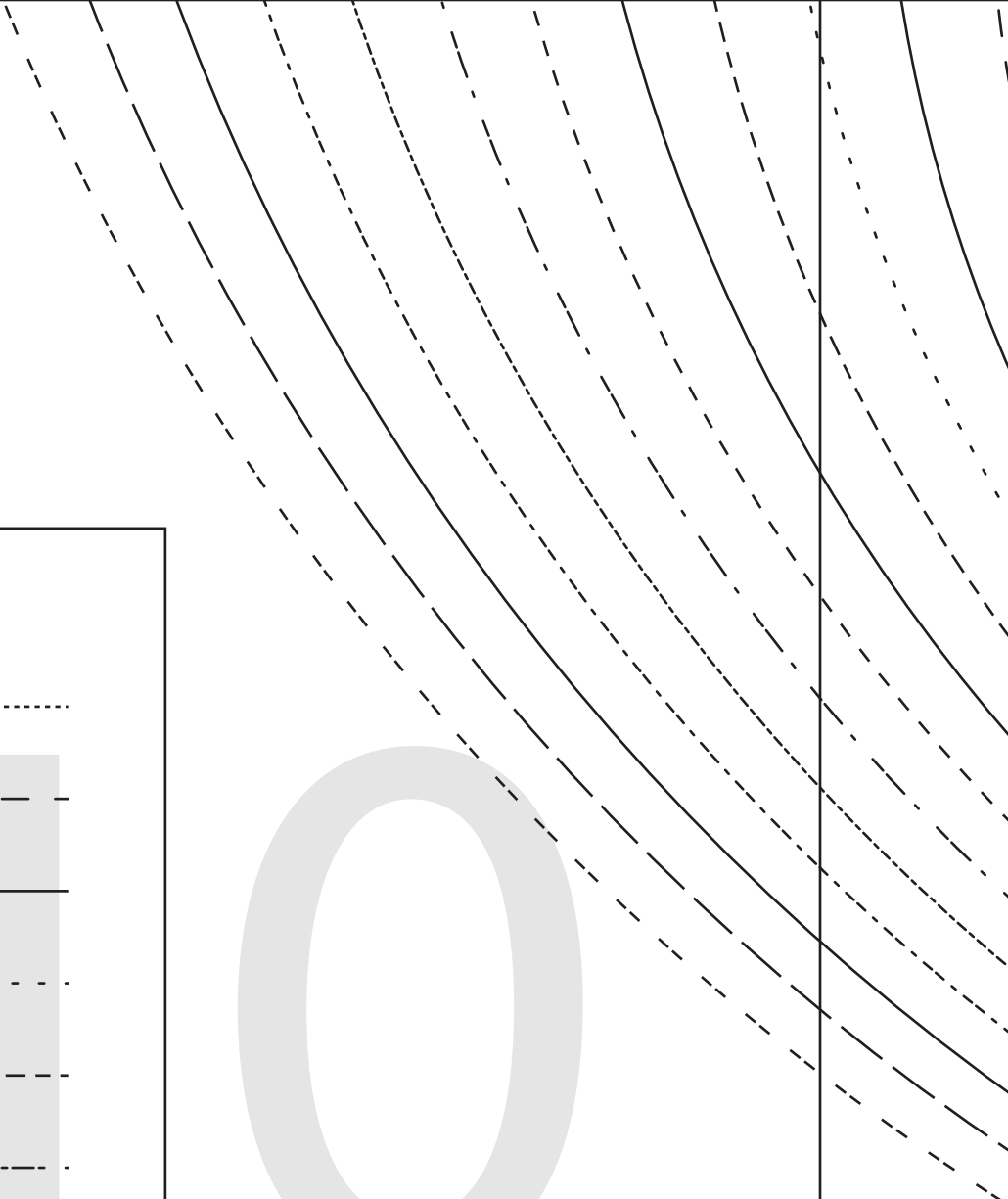
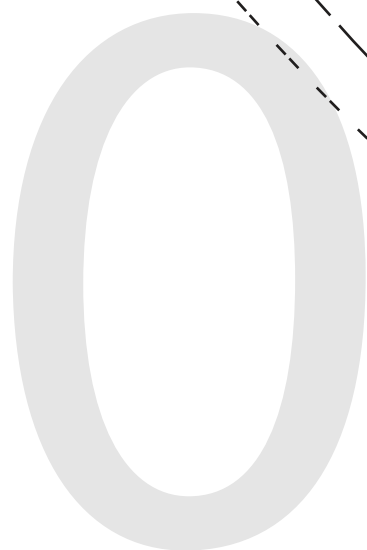

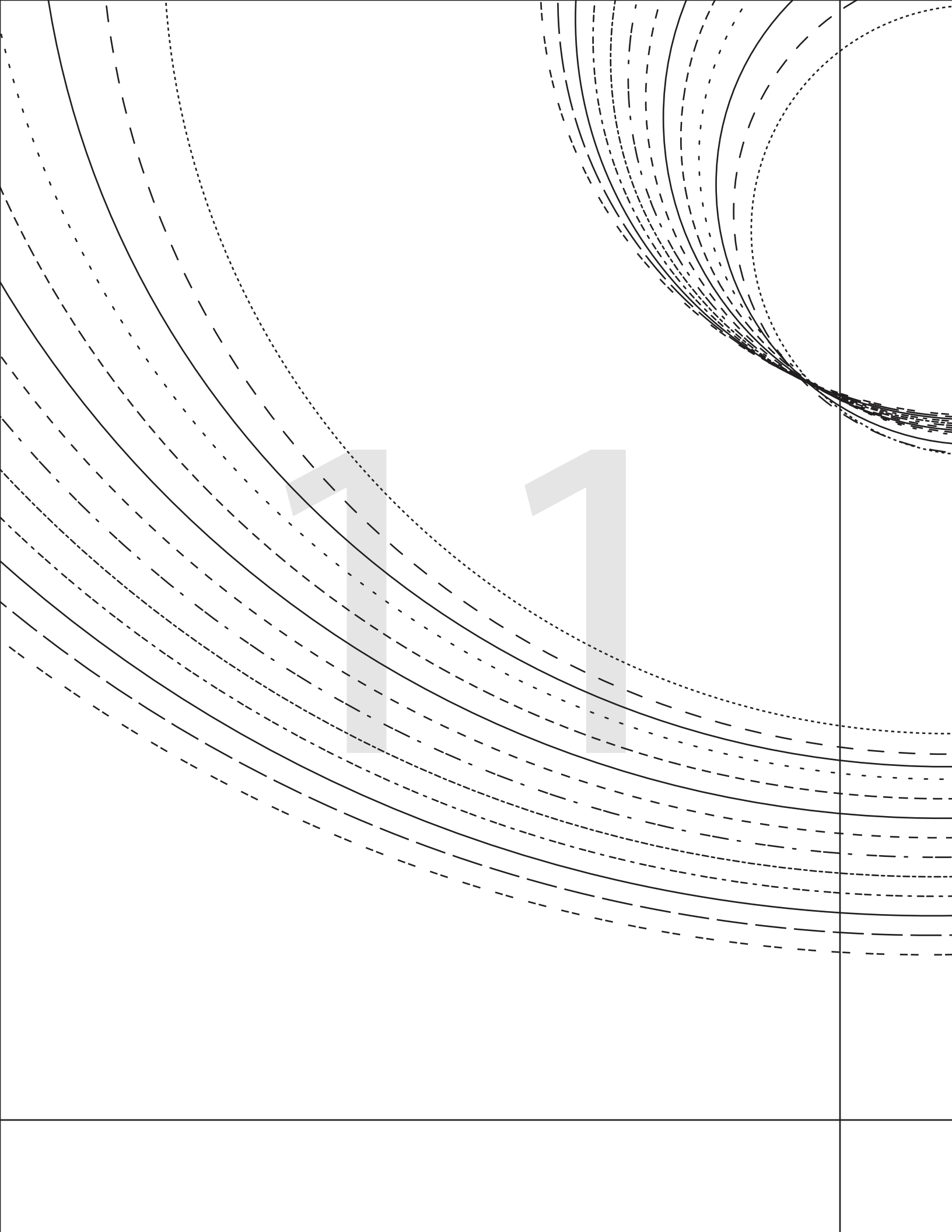

UNDERARM NOTCH

12

