

PRINT TILING TEMPLATE GUIDE FOR SIZE SPECIFIC CHOICE
 TRIM PRINT AT HOME PATTERN

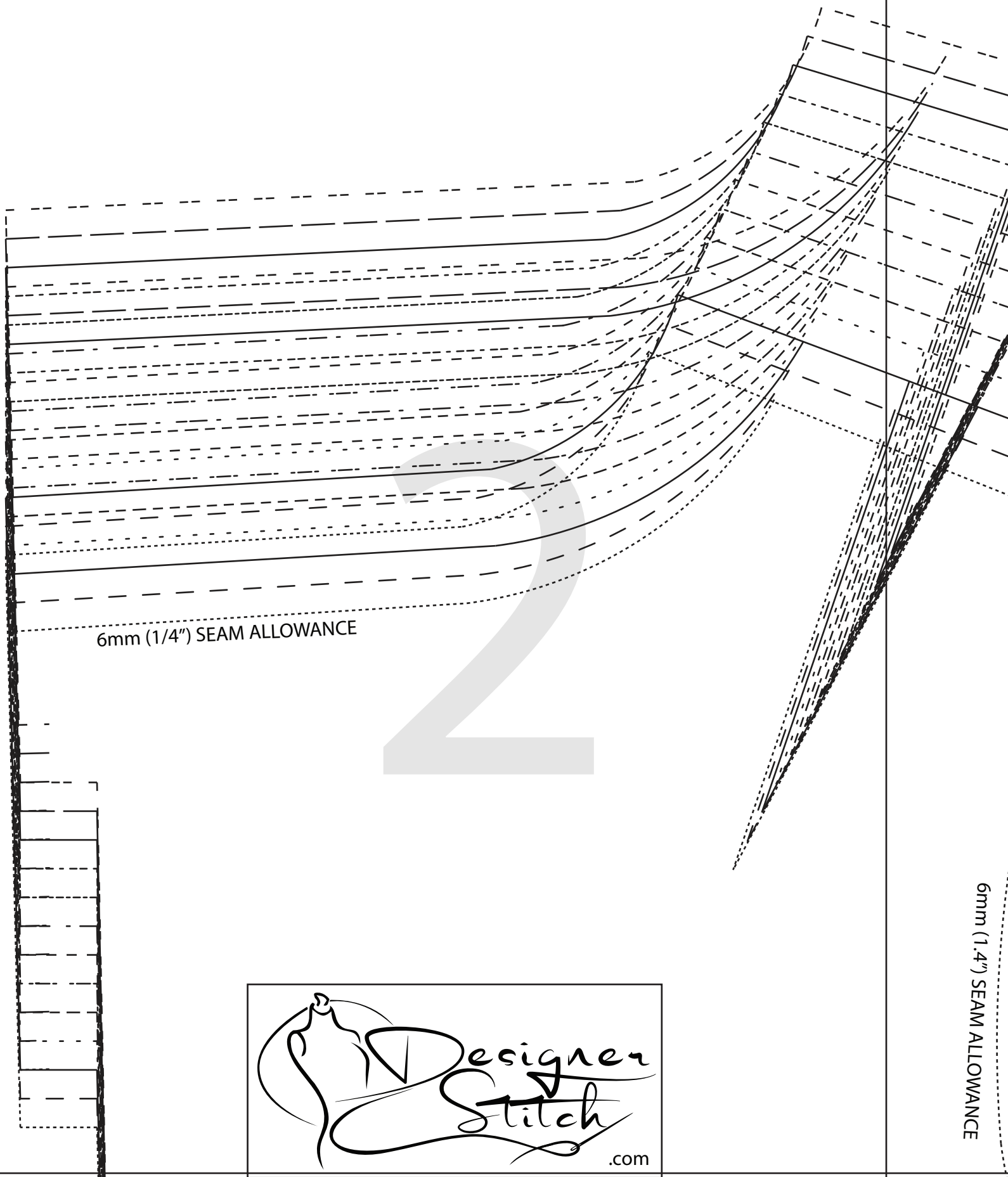

6mm (1/4") SEAM ALLOWANCE

6mm (1.4") SEAM ALLOWANCE

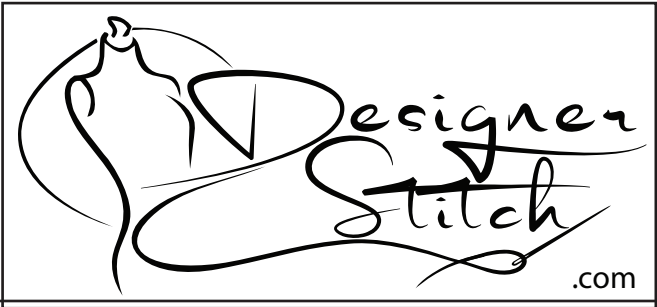

MARIT SHELL TOP

#0522

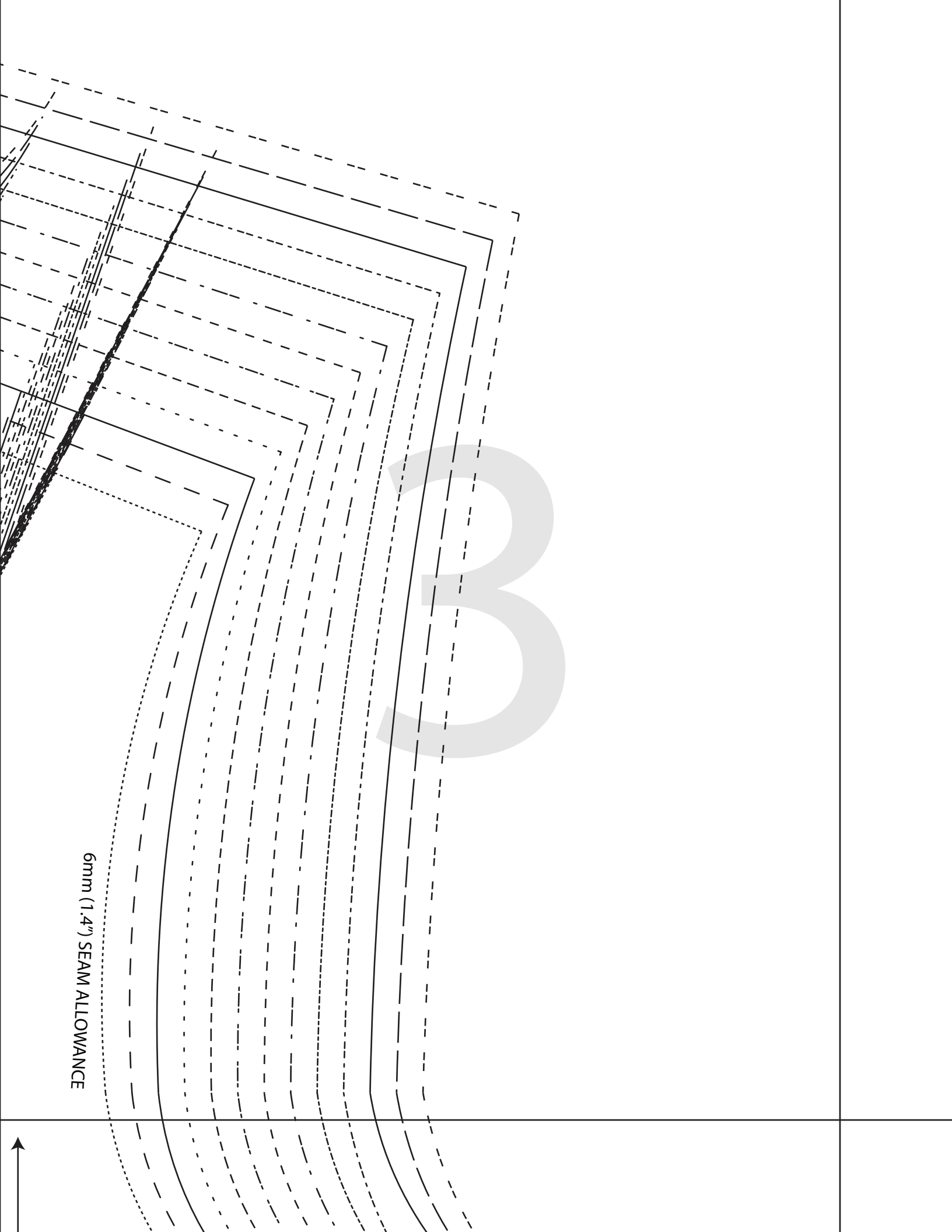

6mm (1.4") SEAM ALLOWANCE



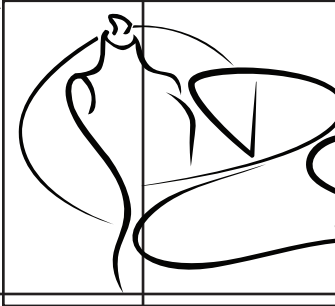
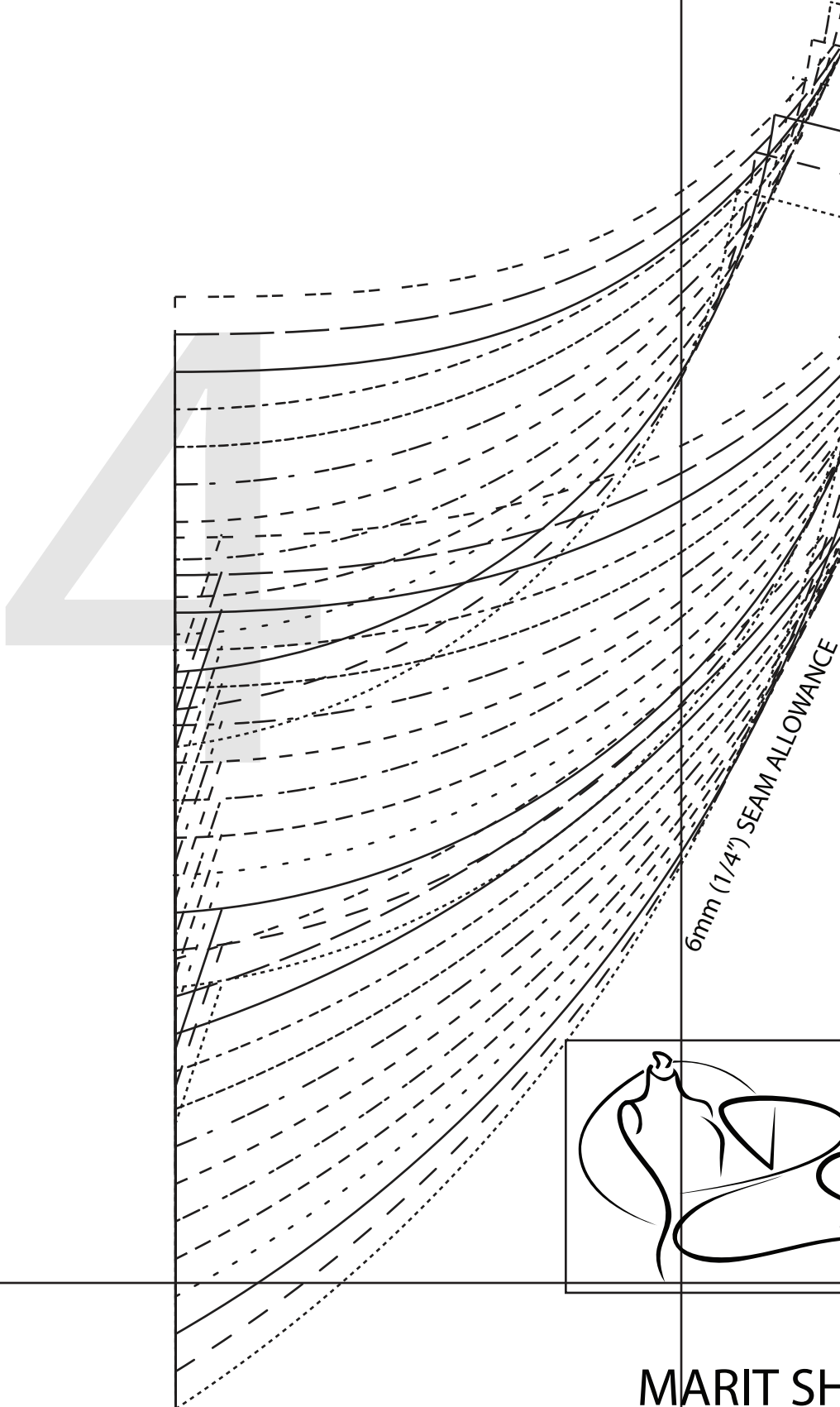

MARIT SH
#05

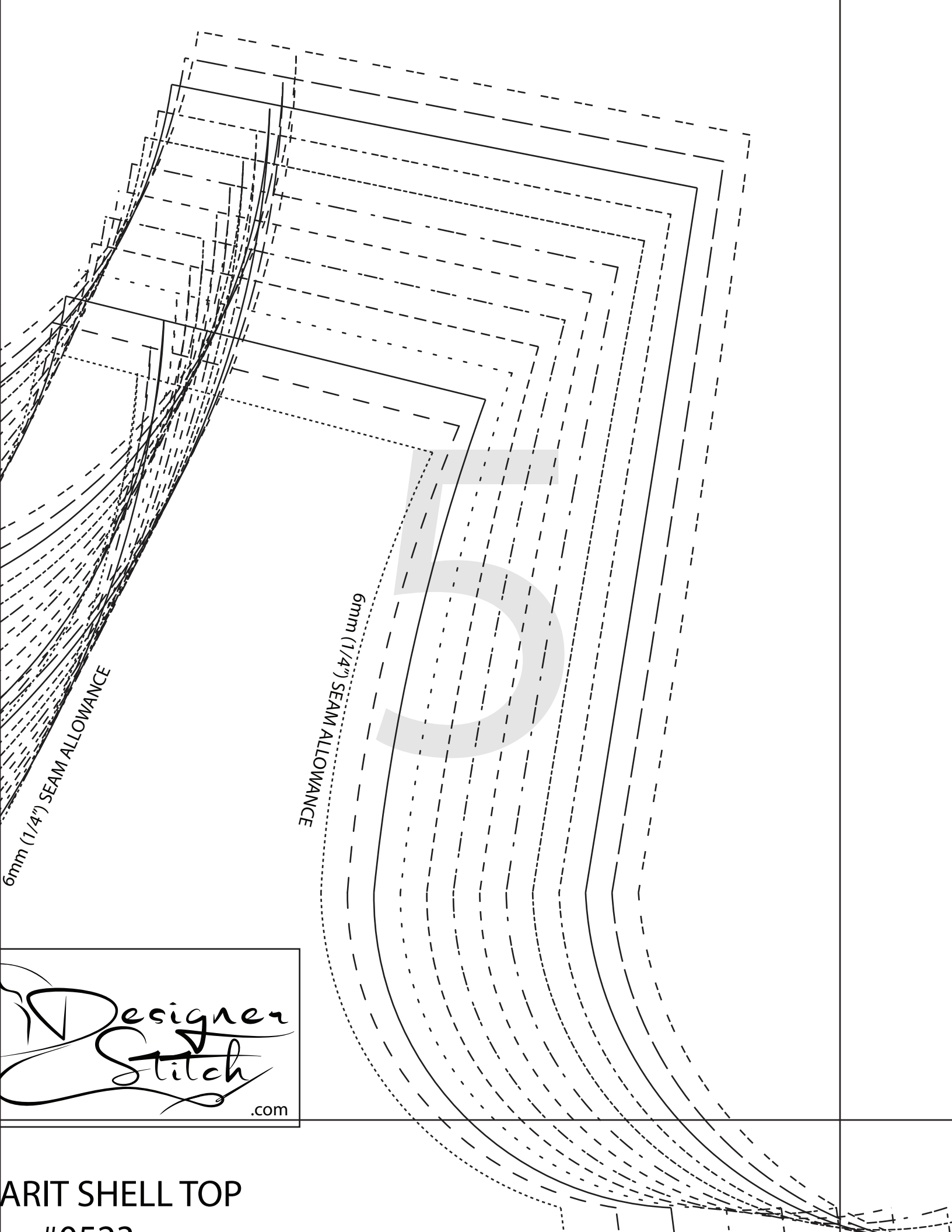

5

6mm (1/4") SEAM ALLOWANCE

6mm (1/4") SEAM ALLOWANCE

Designer
Stitch
.com

PARIT SHELL TOP

#0522



MARIT SHELL TOP

#0523

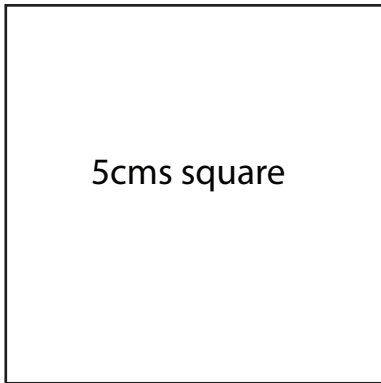

5cms square

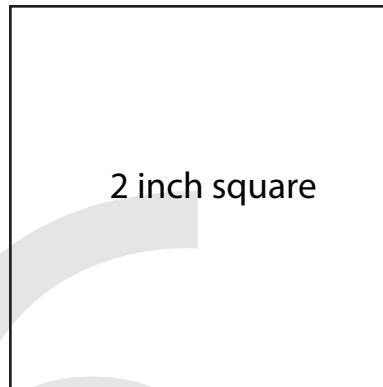

2 inch square

6

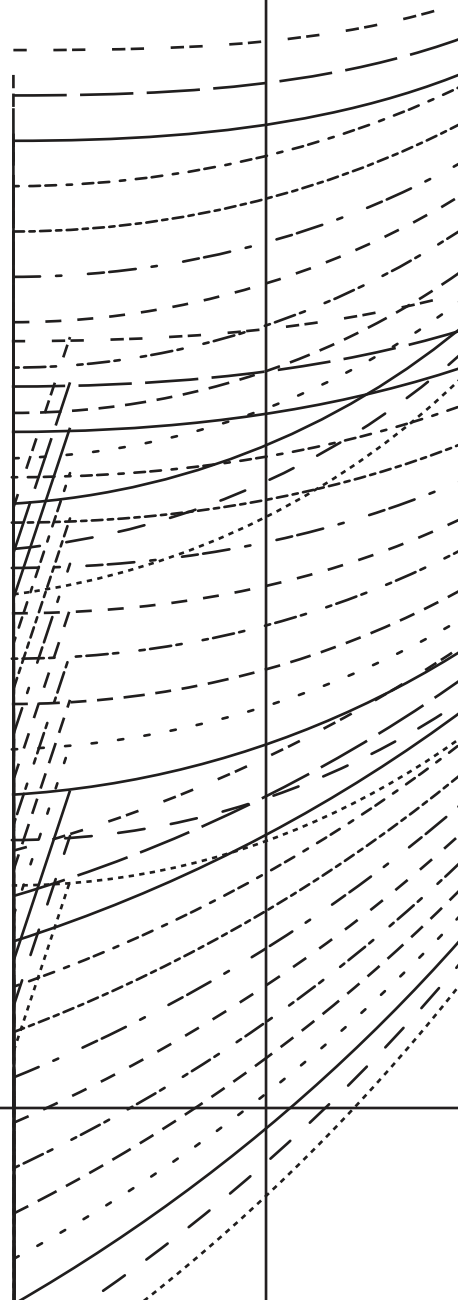

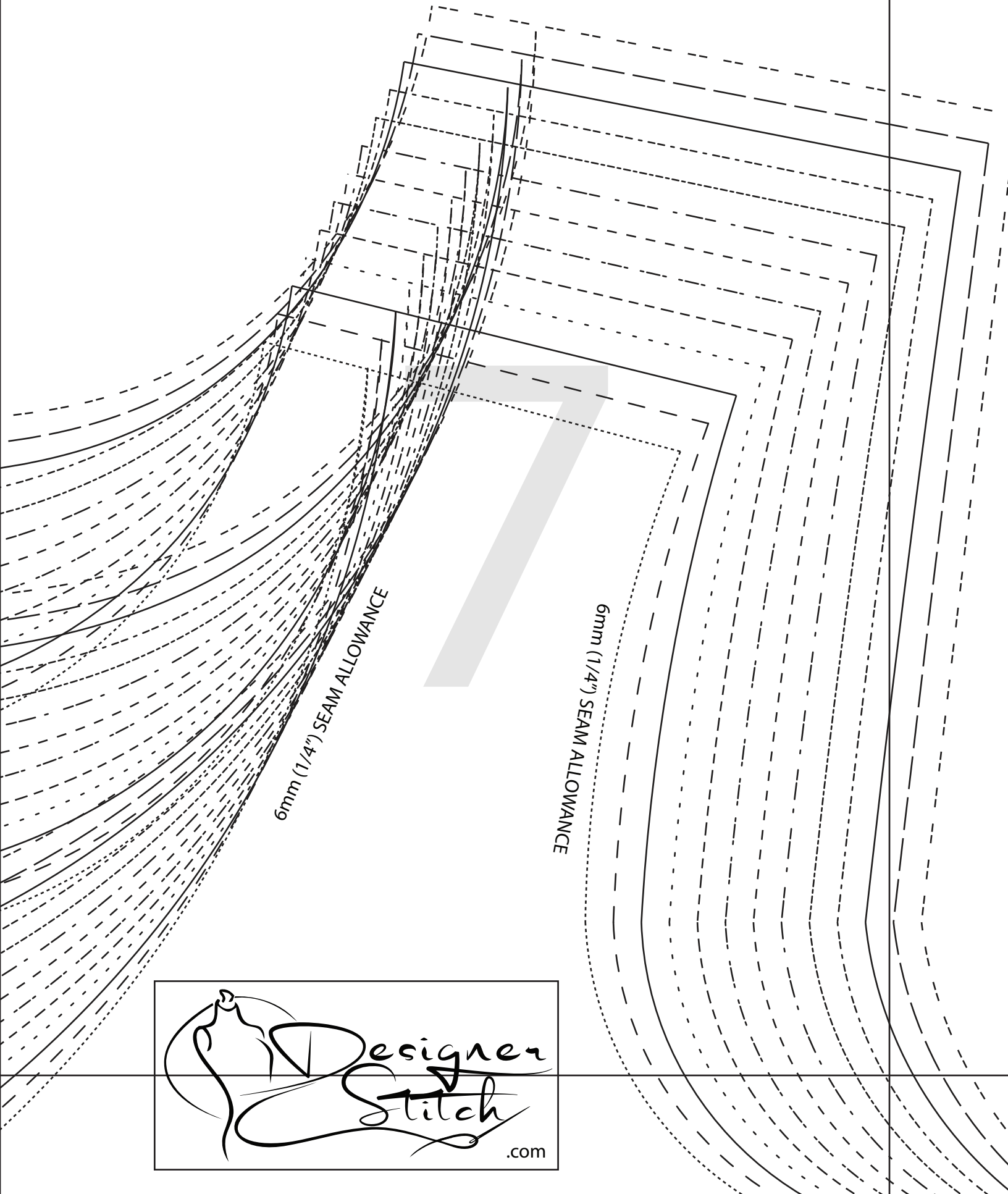

6mm (1/4") SEAM ALLOWANCE

6mm (1/4") SEAM ALLOWANCE

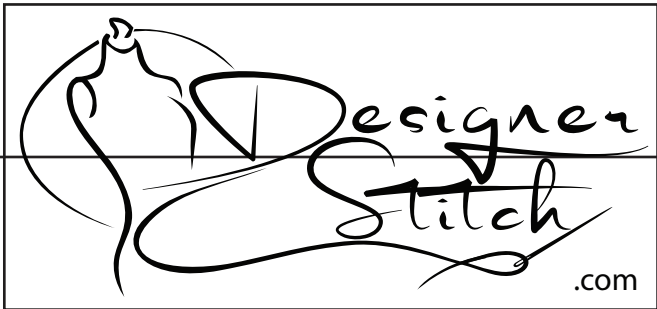

8

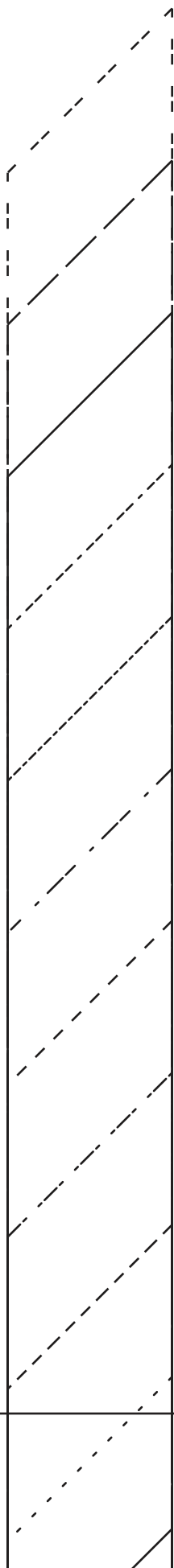

9

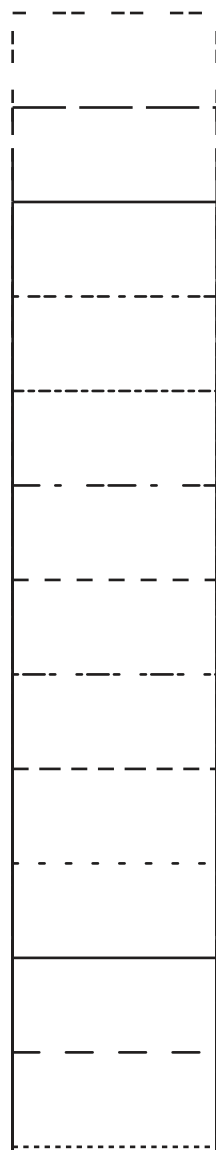
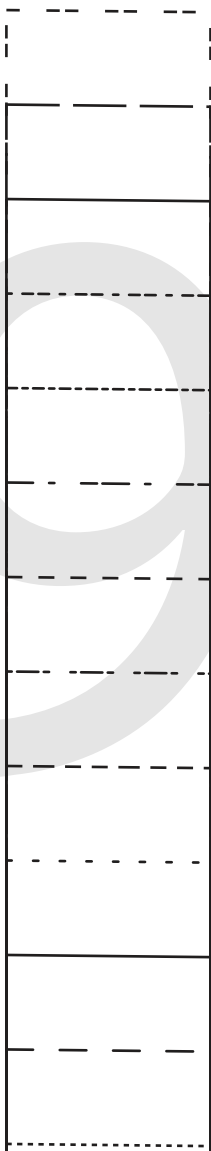

1

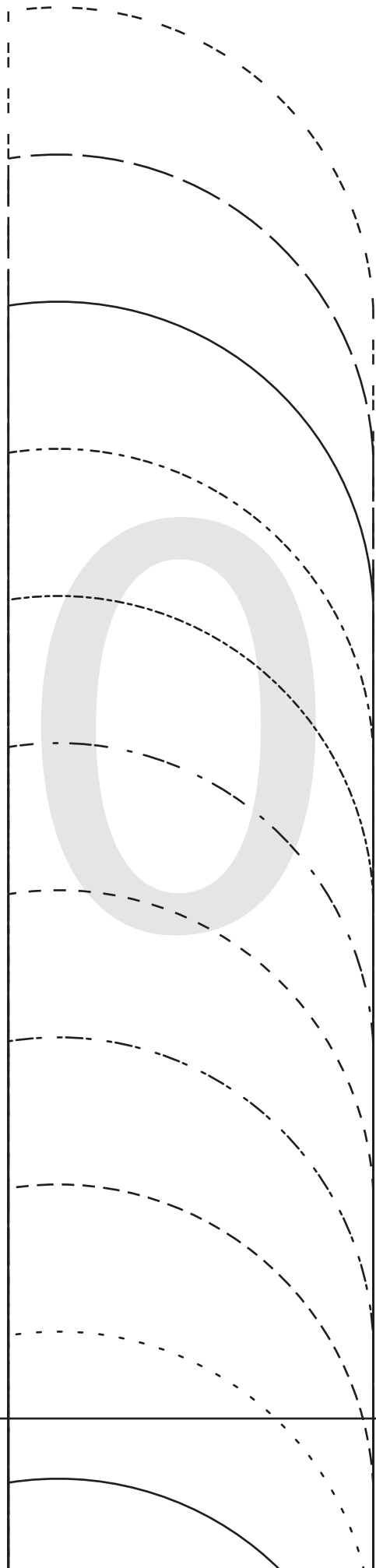

0

MARIT SHELL TOP

#0523

1

BACK

CUT 2

(1.5 cms (5/8") seam allowance unless otherwise stated)

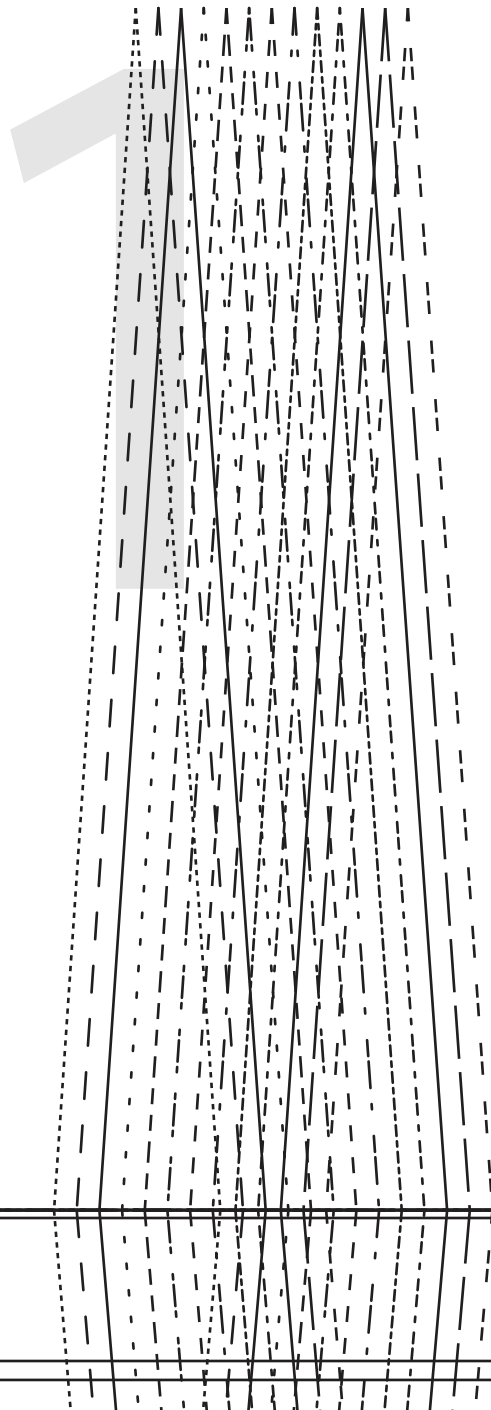

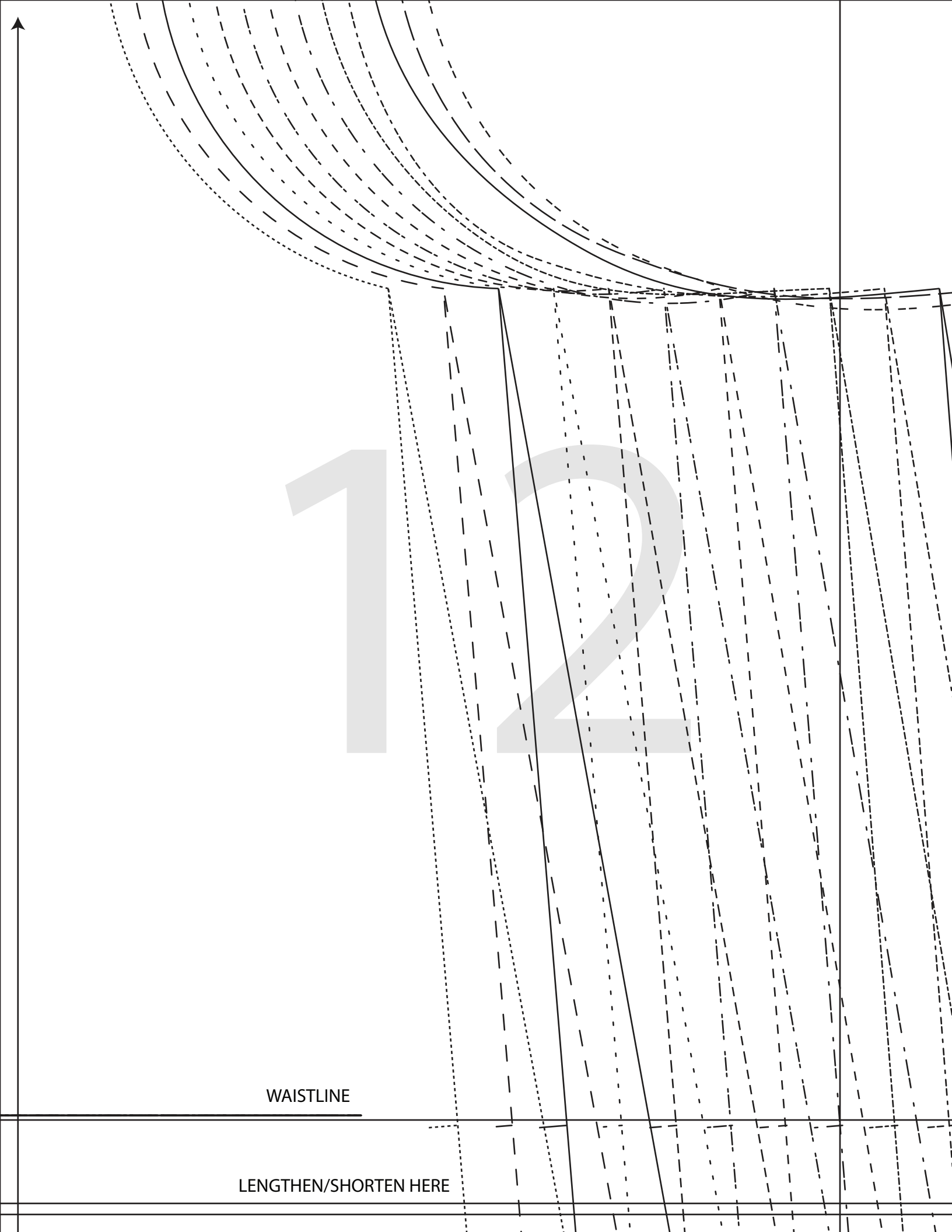

WAISTLINE

LENGTHEN/SHORTEN HERE

MARIT SH

#052

2

FRONT -

CUT 1 P

(1.5 cms (5/8") seam allowance



13

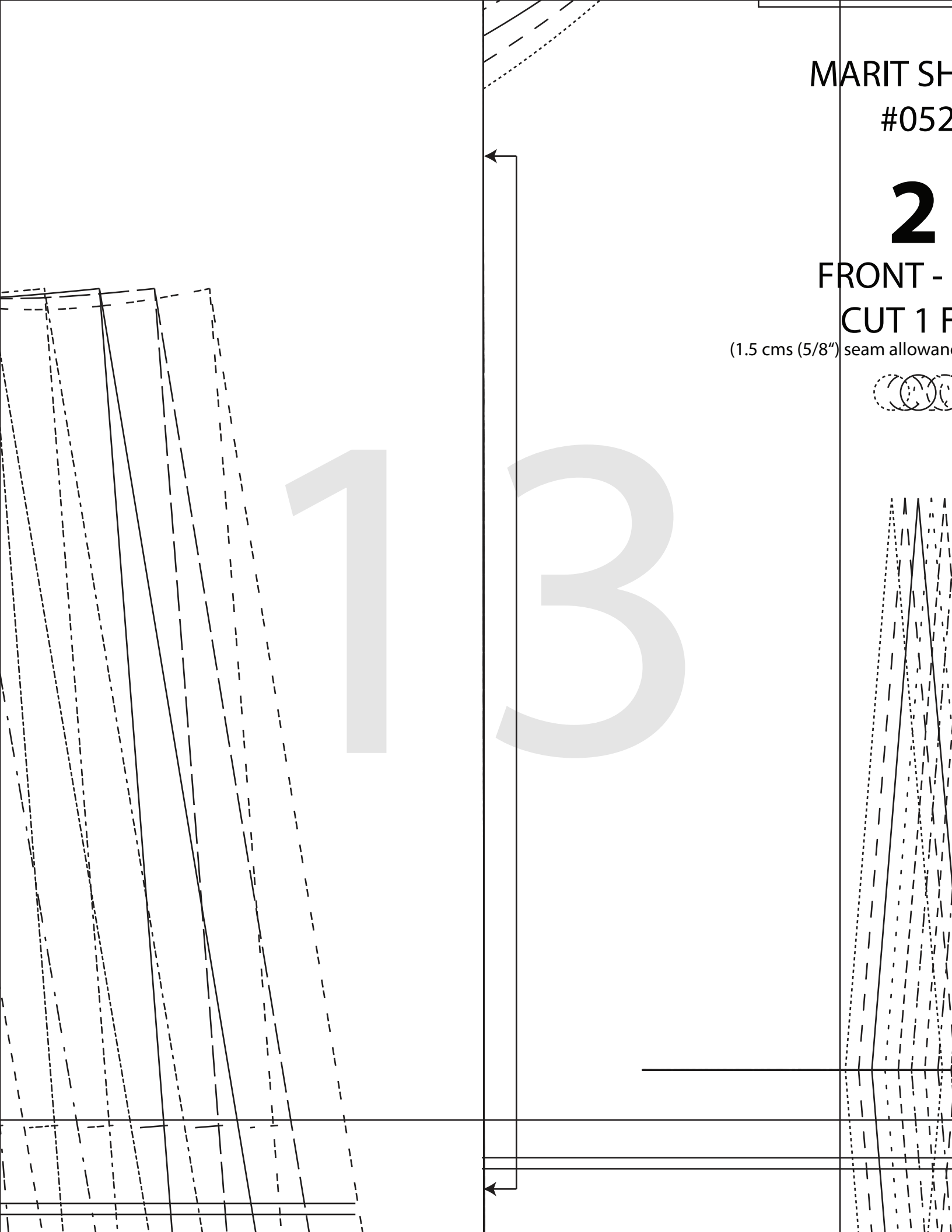

PARIT SHELL TOP

#0523

2

FRONT - A CUP

CUT 1 FOLD

(seam allowance unless otherwise stated)

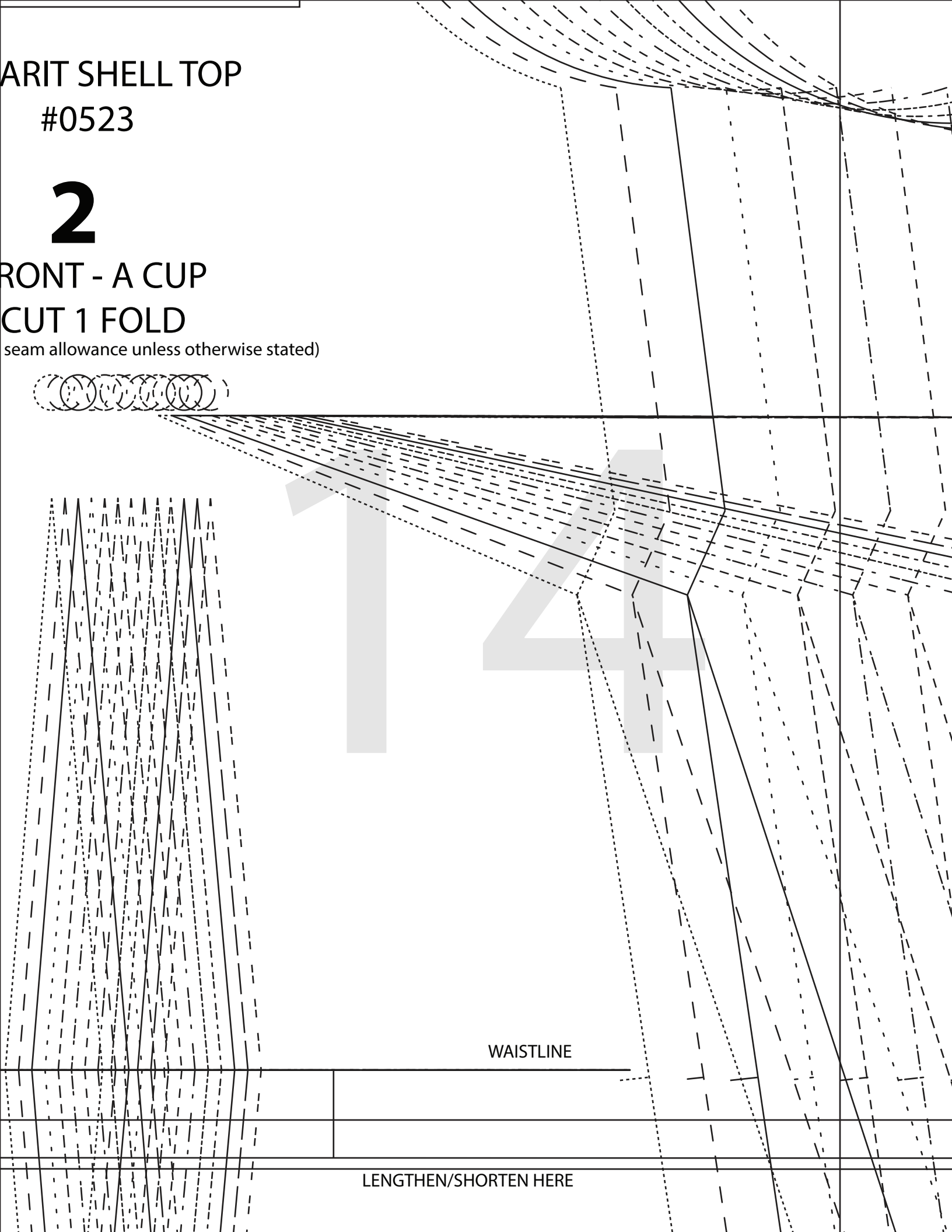

WAISTLINE

LENGTHEN/SHORTEN HERE

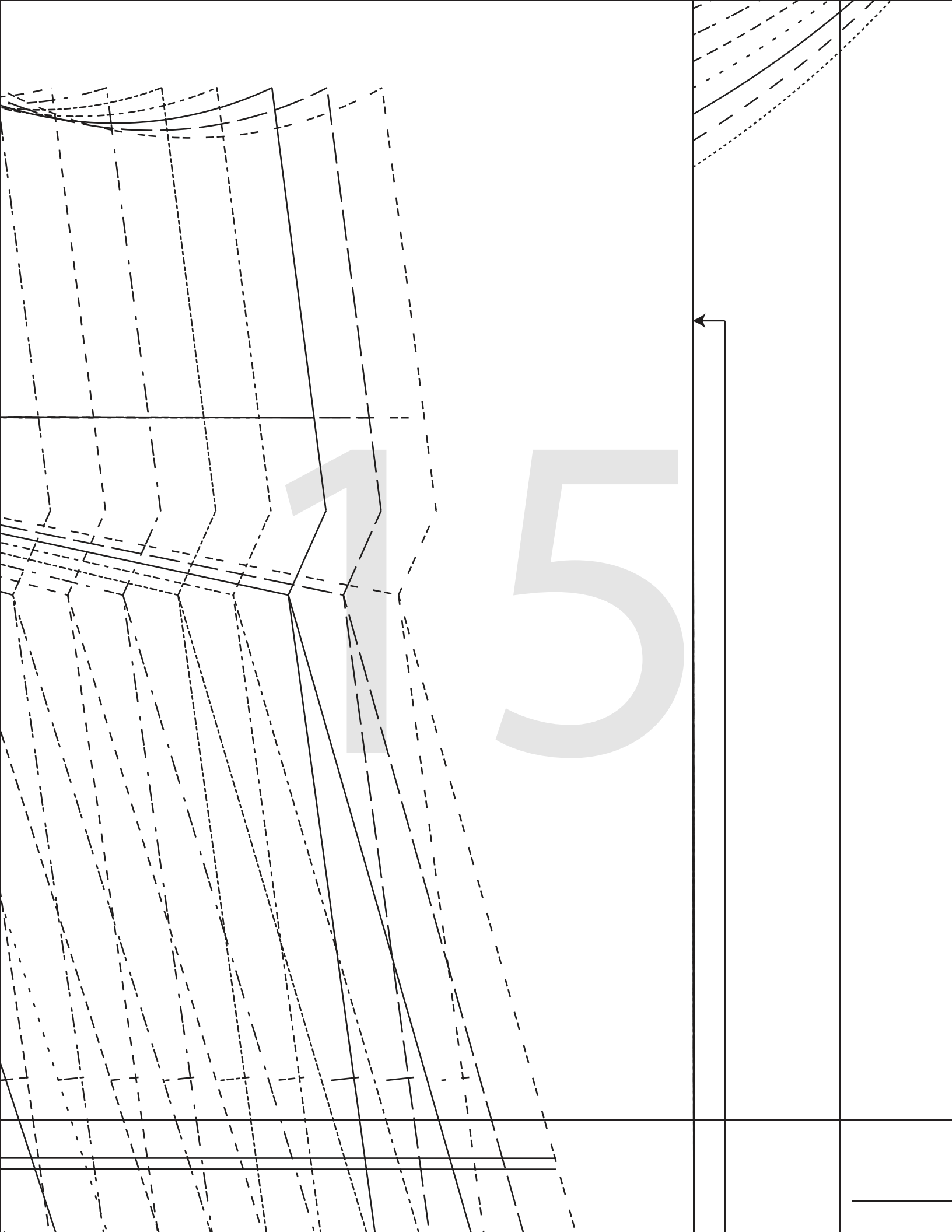

MARIT SHELL TOP

#0523

2

FRONT - B CUP

CUT 1 FOLD

(1.5 cms (5/8") seam allowance unless otherwise stated)

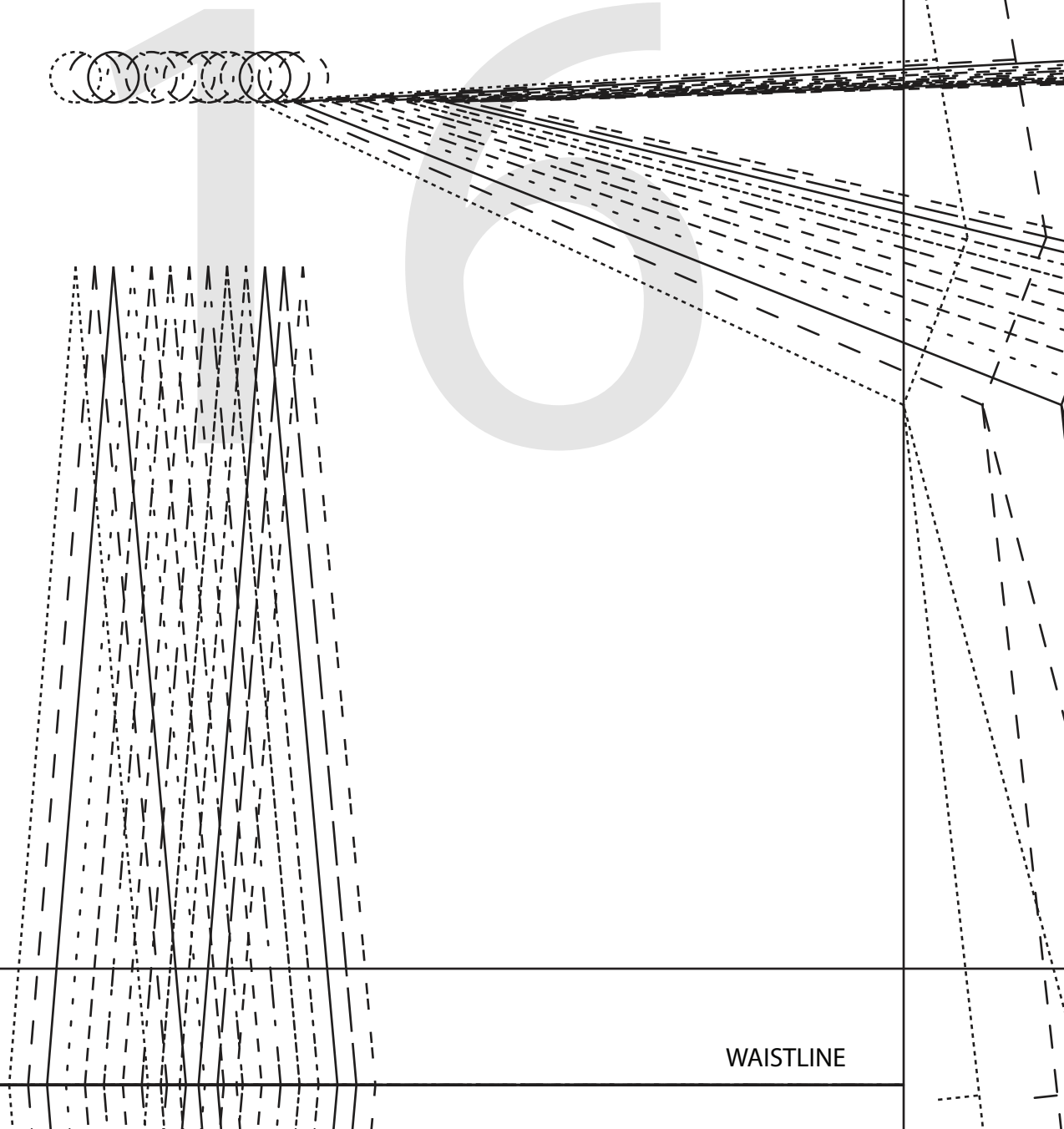

WAISTLINE

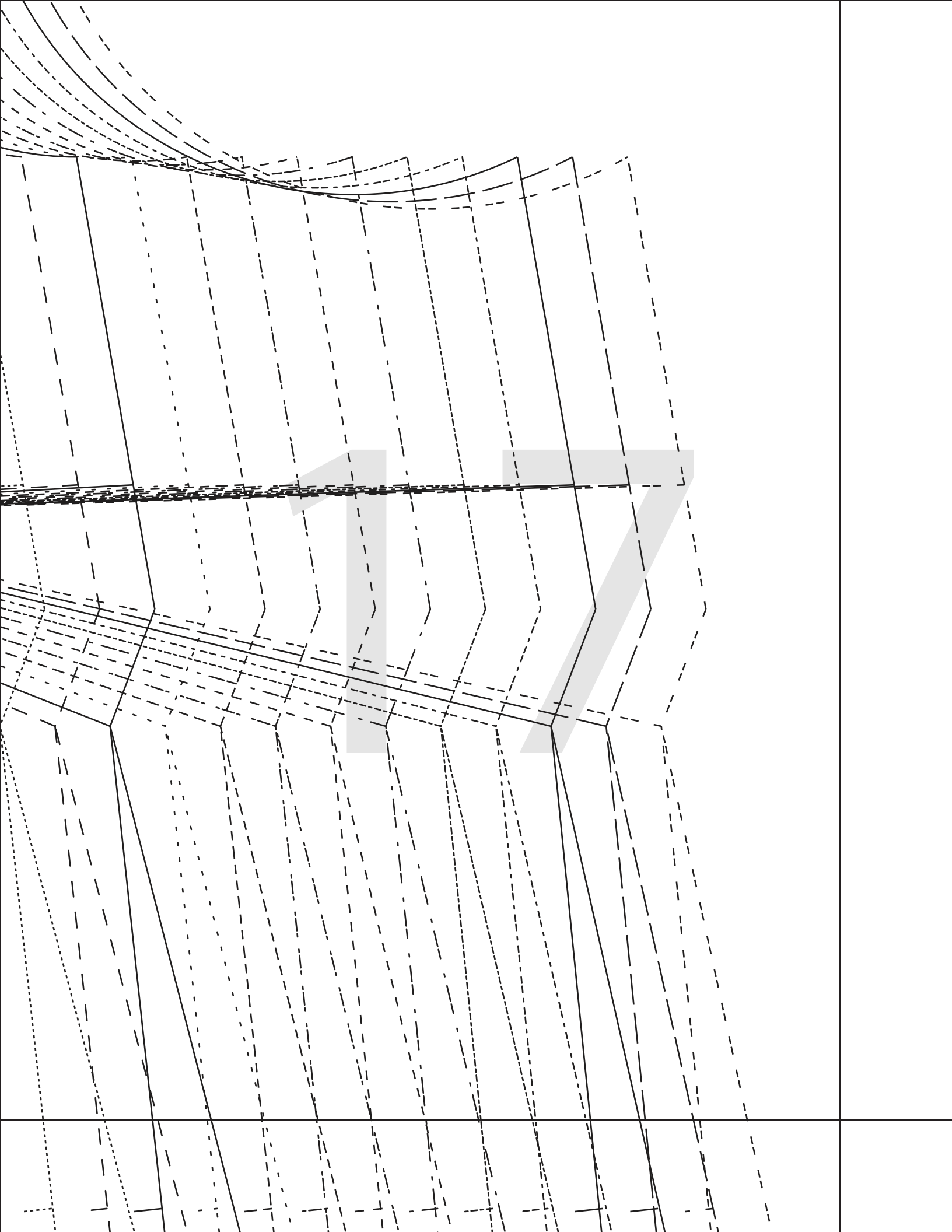

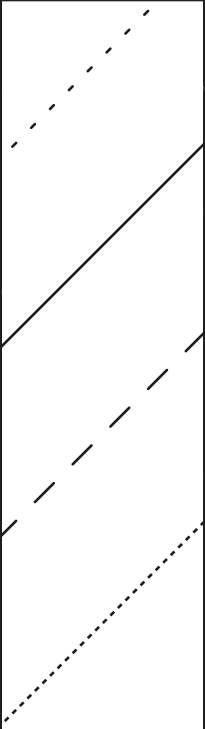

MARIT SHELL TOP
#0523

8

ARMHOLE BIND
CUT 2

(6mm (1/4") seam allowance unless otherwise stated)



MARIT SHELL TOP
#0523

7

HIGH NECK BIND
CUT 1

(6mm (1/4") seam allowance unless otherwise stated)



MARIT SHELLTOP
#0523

6

SCOOP NECK BIND
CUT 1

(6mm (1/4") seam allowance unless otherwise stated)



1

9

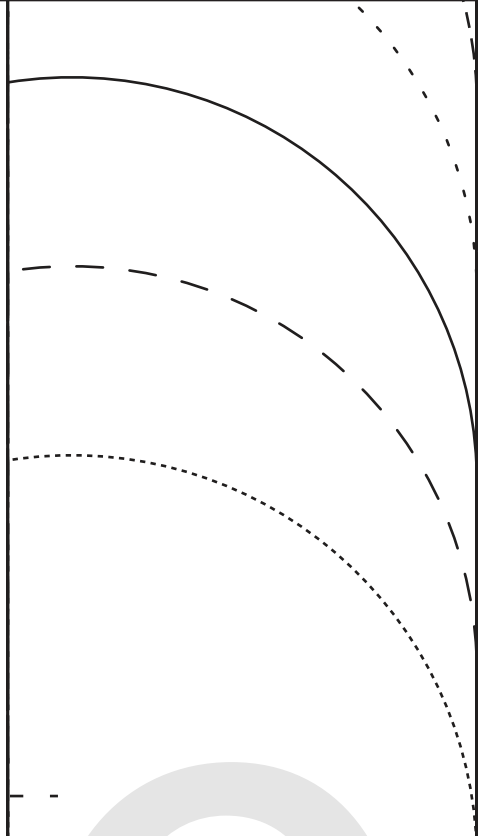

HELL TOI[
3

CAP SLEEVE
2 - (or 4)
(unless otherwise stated)

2 cms (3/4") HEM ALLOWANCE

2 cms (3/4") HEM ALLOWANCE

2 cms (3/4") HEM ALLOWANCE

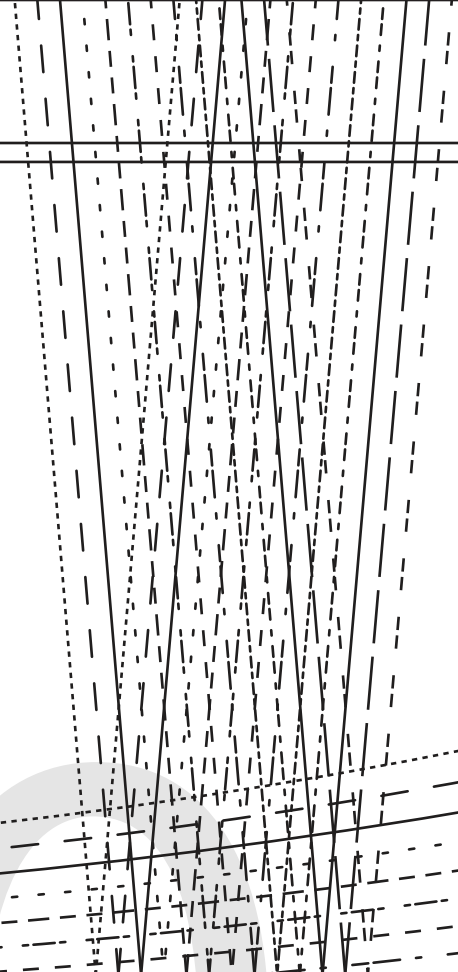

LENGTHEN/SHORTEN HERE

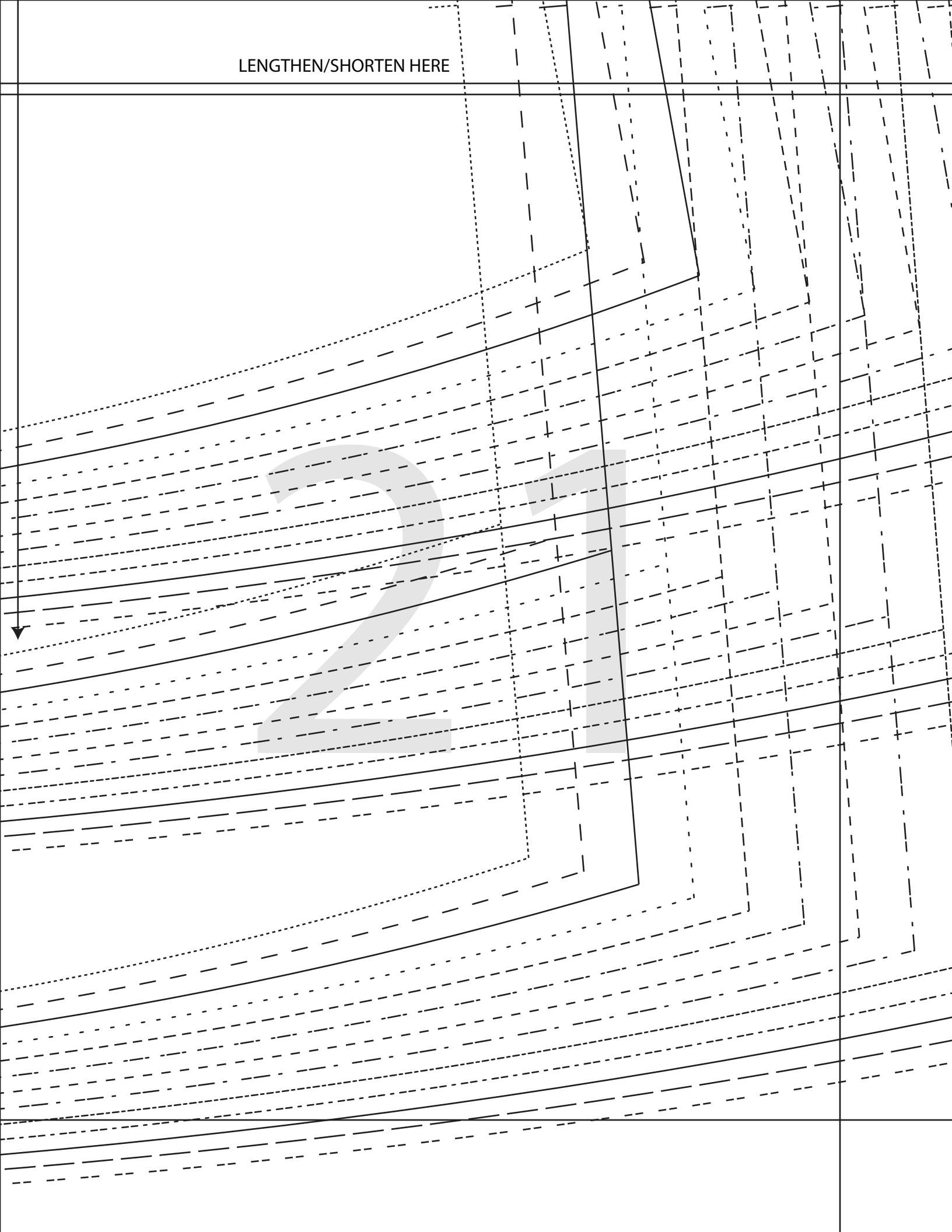

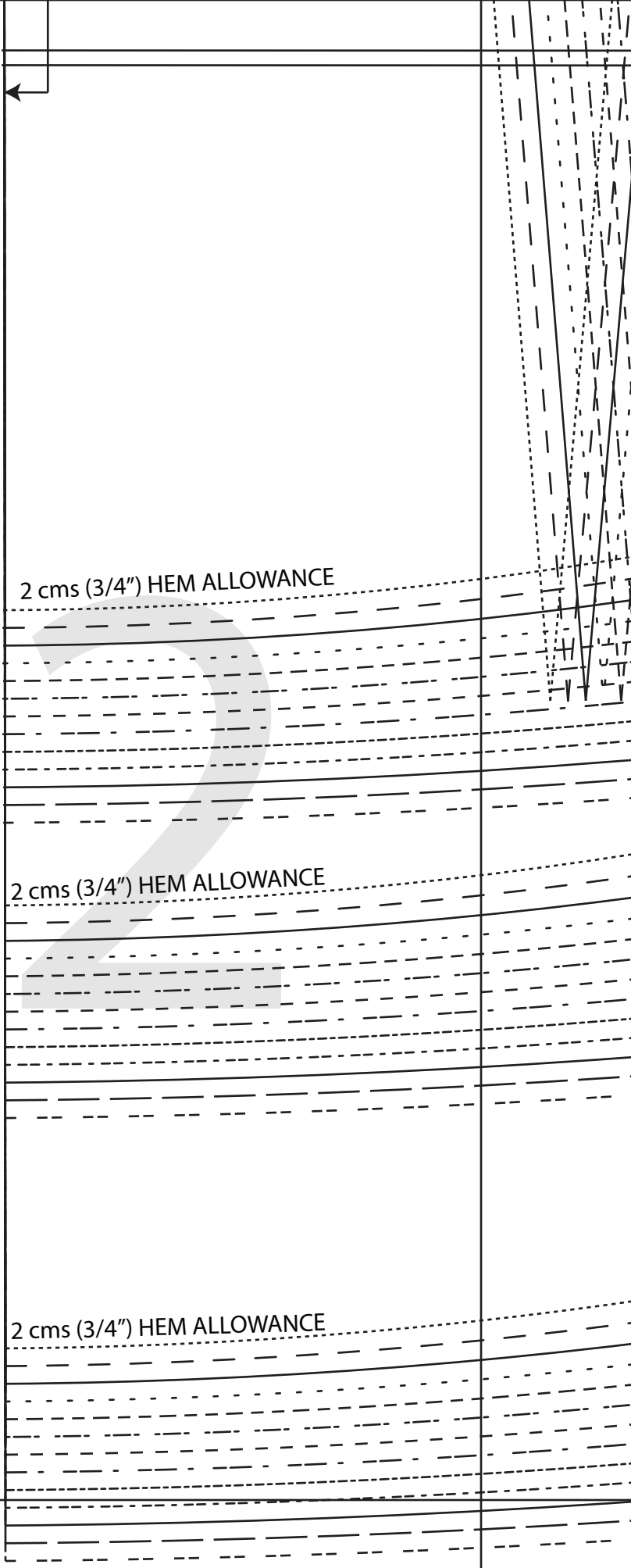
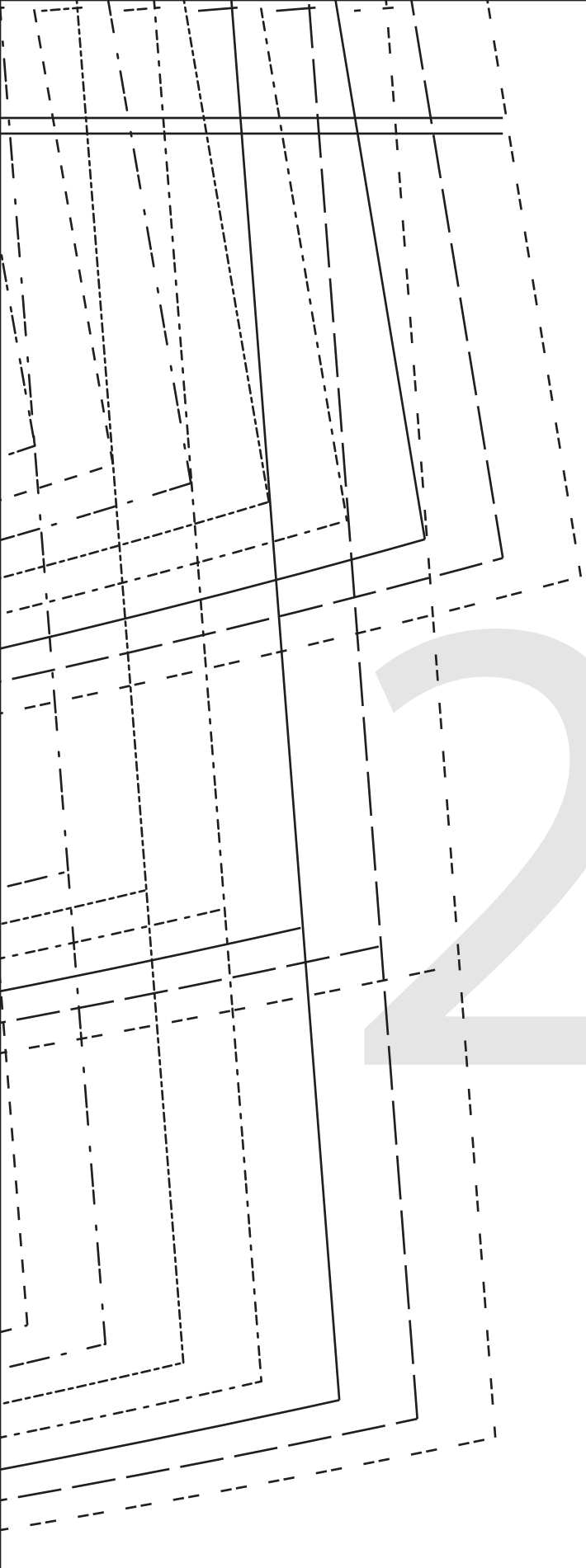

2 cms (3/4") HEM ALLOWANCE

2 cms (3/4") HEM ALLOWANCE

2 cms (3/4") HEM ALLOWANCE

LENGTHEN/SHORTEN HERE

23

WAISTLINE

LENGTHEN/SHORTEN HERE

ALLOWANCE

ALLOWANCE

ALLOWANCE

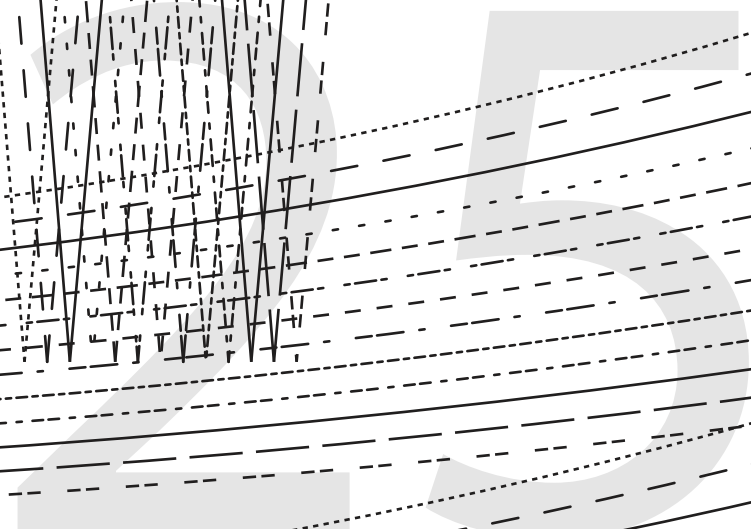

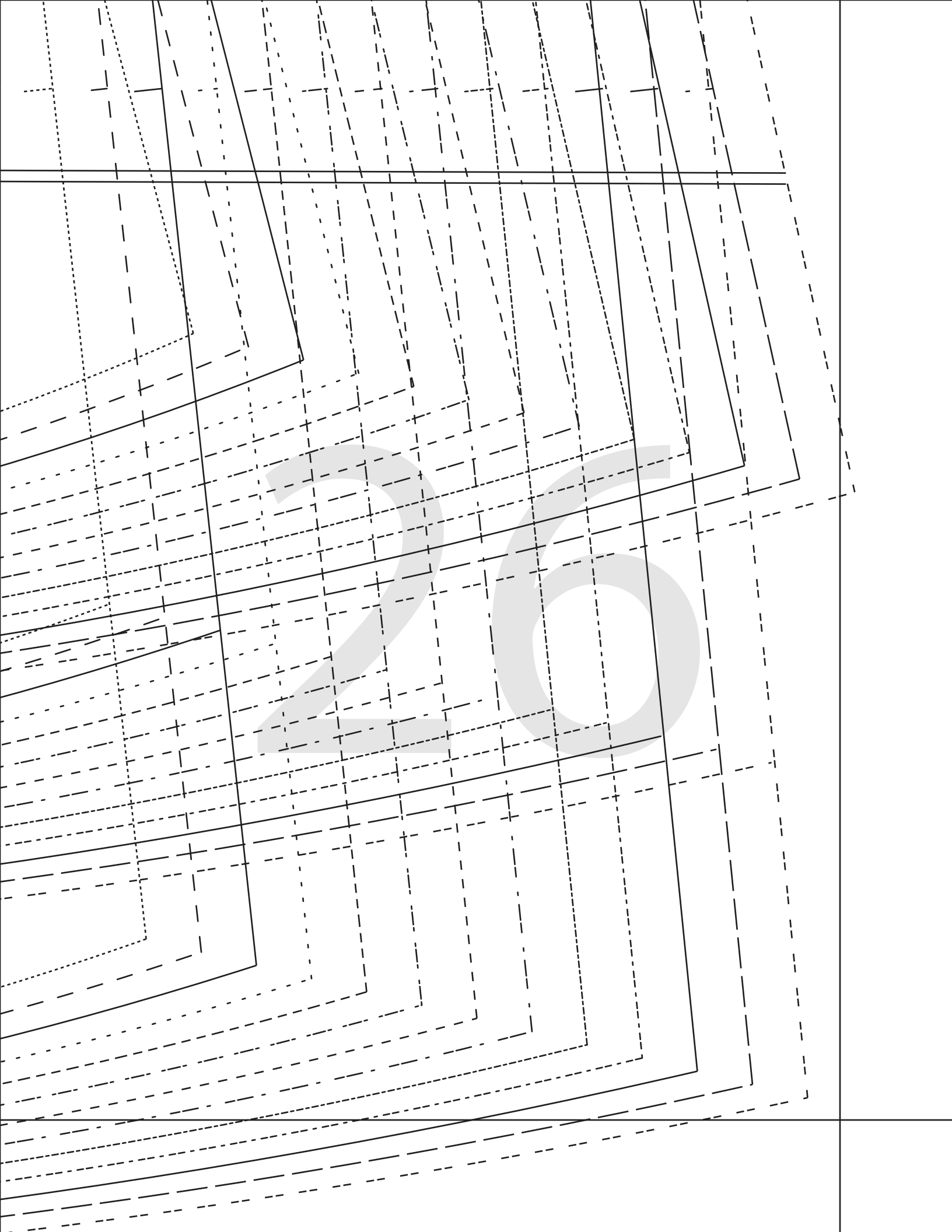

27

2

8



MARIT SHELL TOI
#0523

4

RUFFLED CAP SLEEVE
CUT 2 - (or 4)

(6mm (1/4") seam allowance unless otherwise stated)



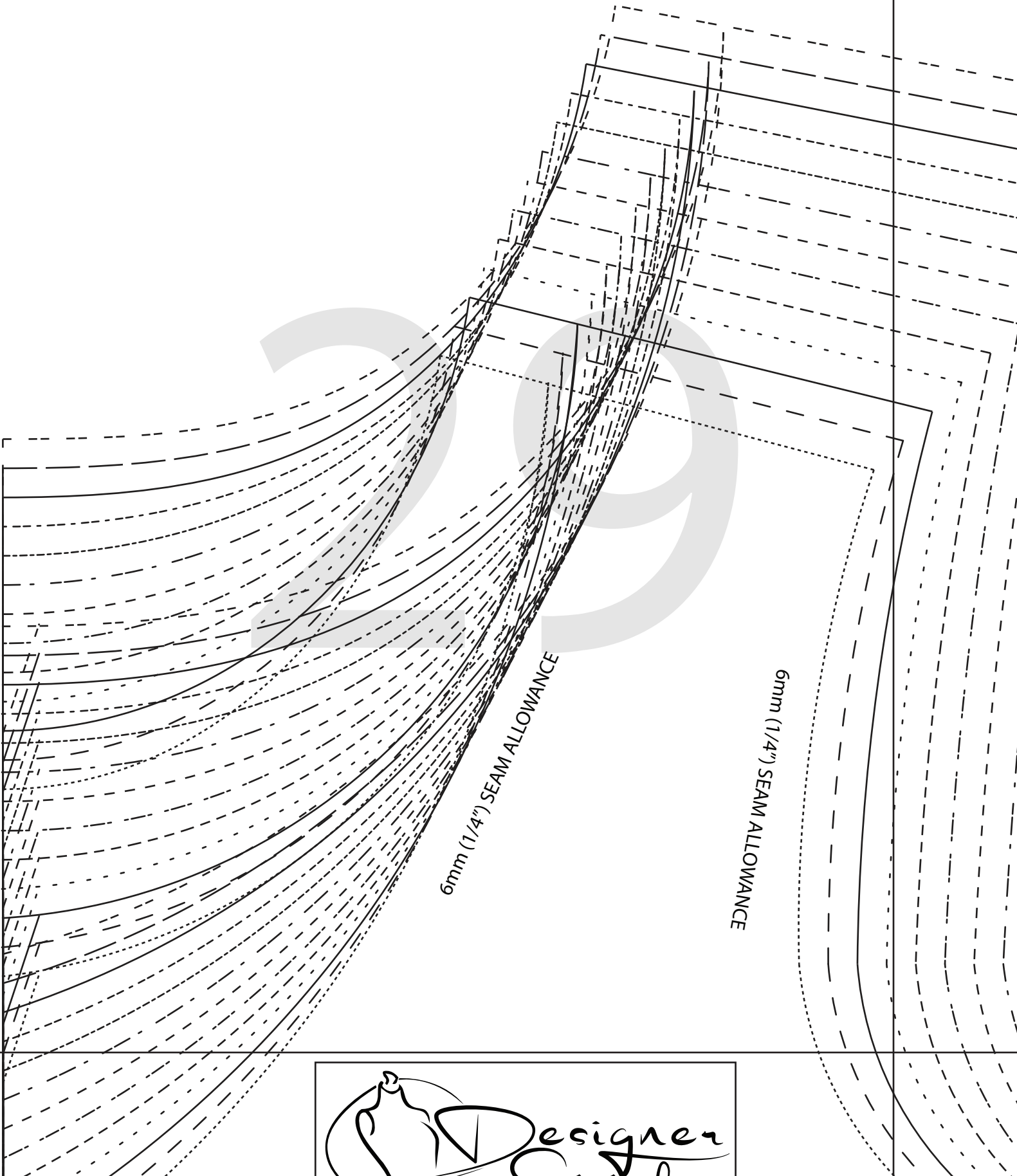

6mm (1/4") SEAM ALLOWANCE

6mm (1/4") SEAM ALLOWANCE



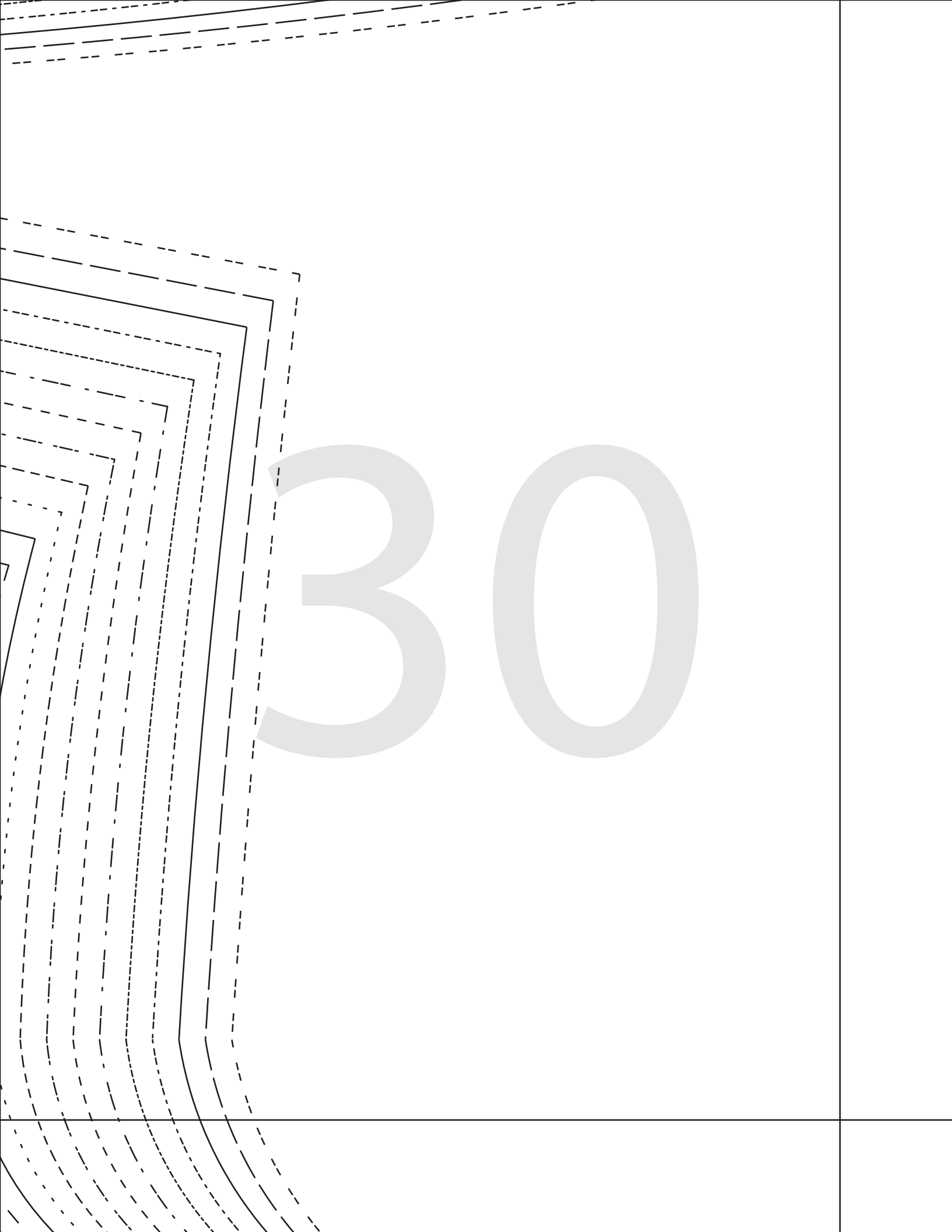

30

31

6mm (1/4") SEAM ALLOWANCE

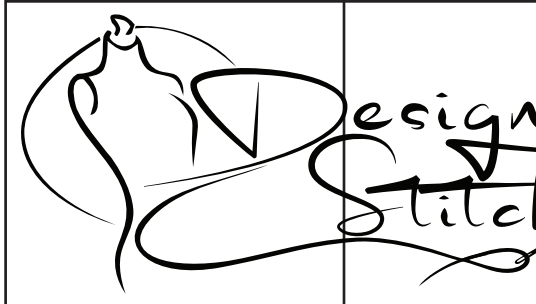

MARIT SHELL TOP

#0523

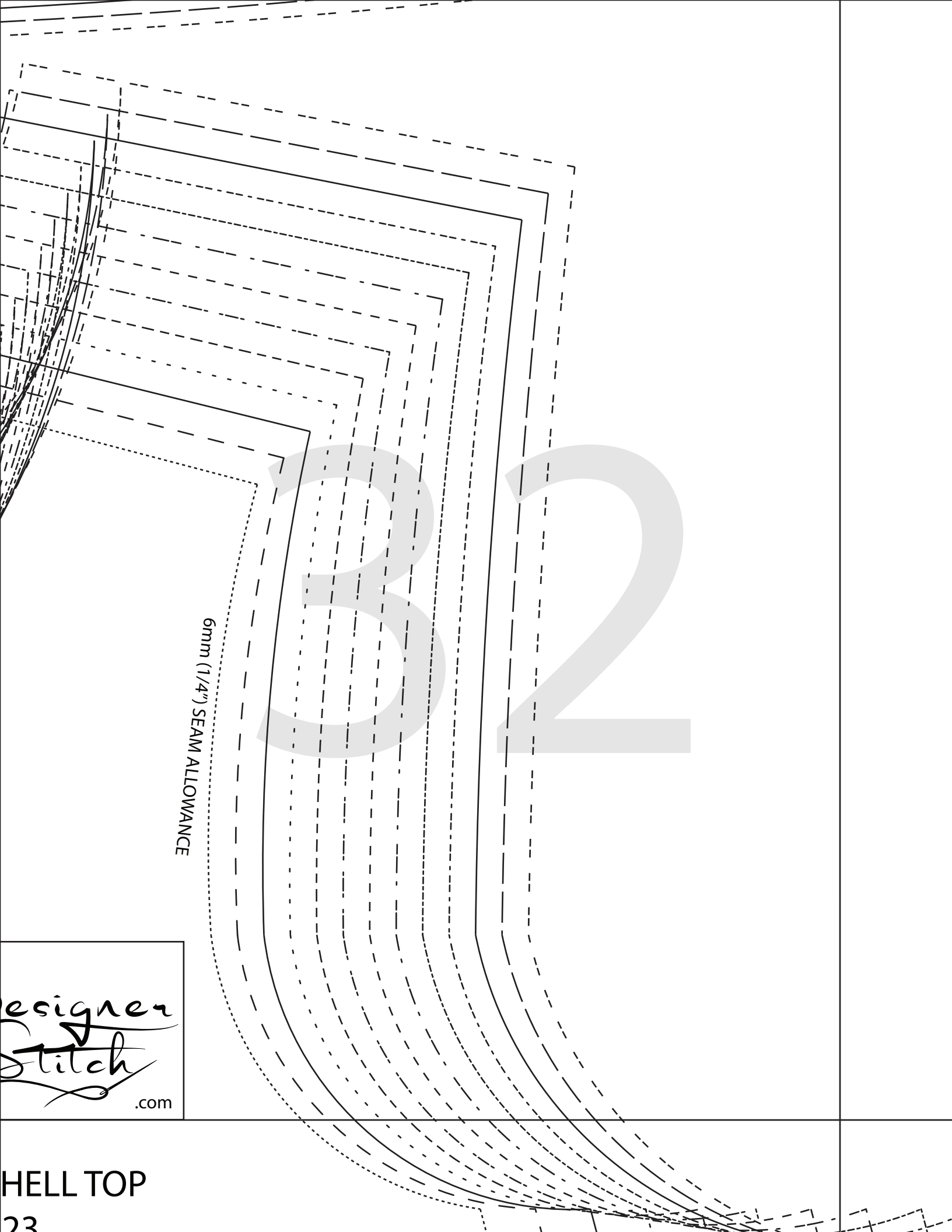

32

6mm (1/4") SEAM ALLOWANCE

Designer
Stitch
.com

HELL TOP

23

2 cms (3/4) ITEM ALLOWANCE	

33

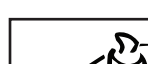
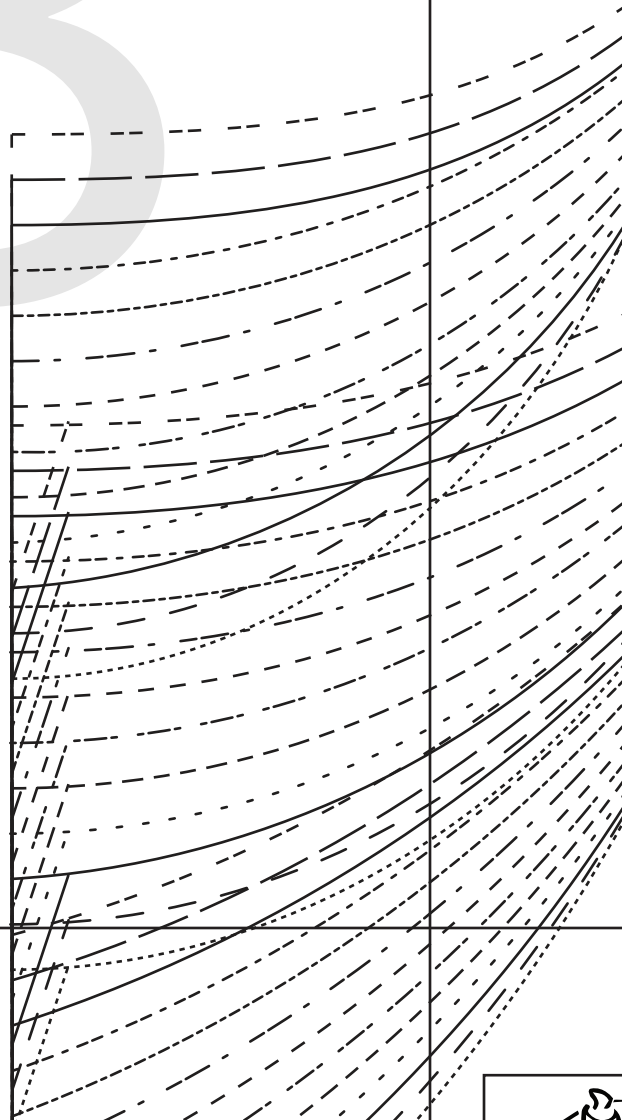

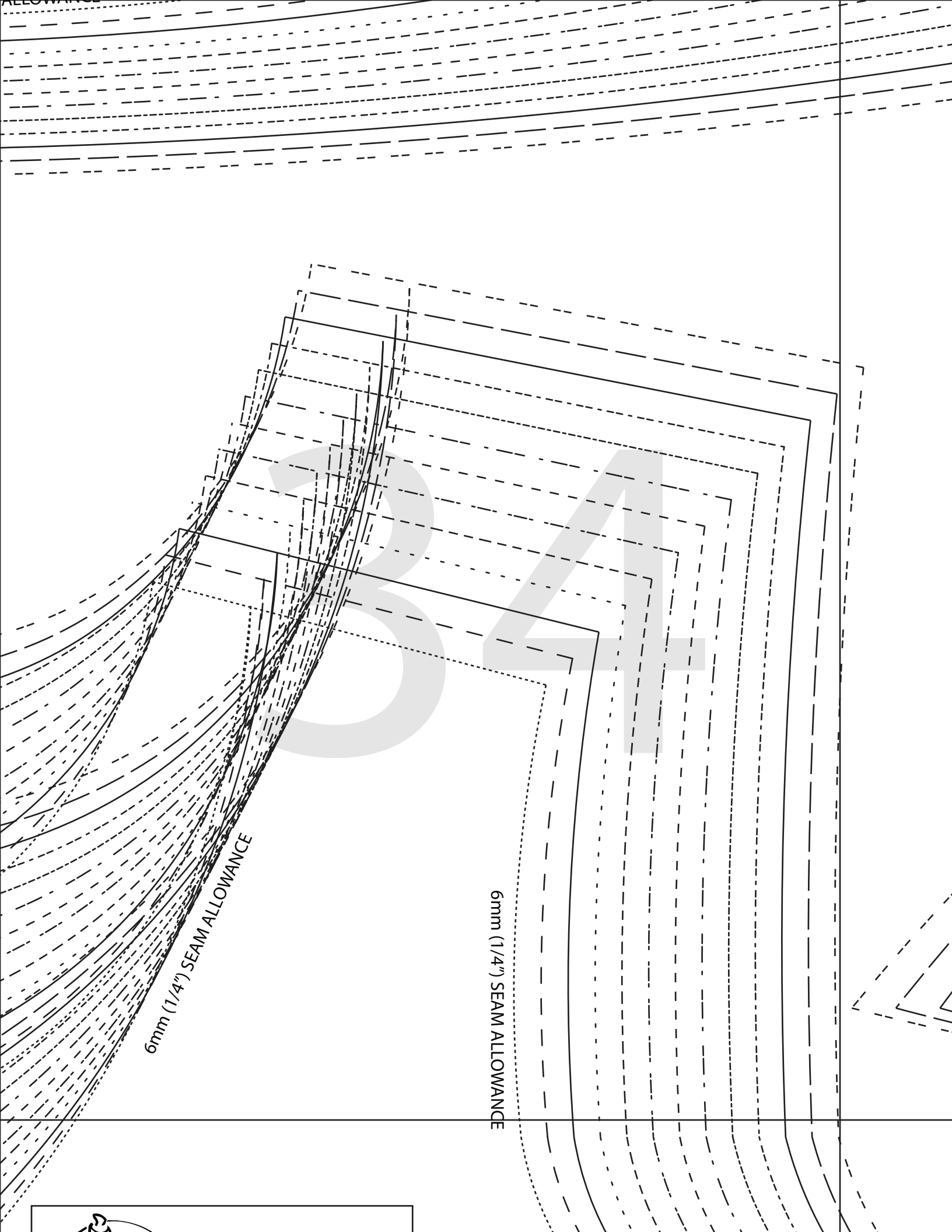

6mm (1/4") SEAM ALLOWANCE

6mm (1/4") SEAM ALLOWANCE





MARIT SHELL TOP
#0523

9

NOTCH NECK FACING
CUT 1- MAIN/
INTERFACING

(6mm (1/4") seam allowance
unless otherwise stated)

35

6mm (1/4") SEAM ALLOWANCE



MARIT

CAP

C

(1.5 cms (5/8") seam allowance)





MARIT SHELL TOP
#0523

3

CAP SLEEVE
CUT 2

(1.5 cms (5/8") seam allowance unless otherwise stated)

6mm (1/4") SEAM ALLOWANCE

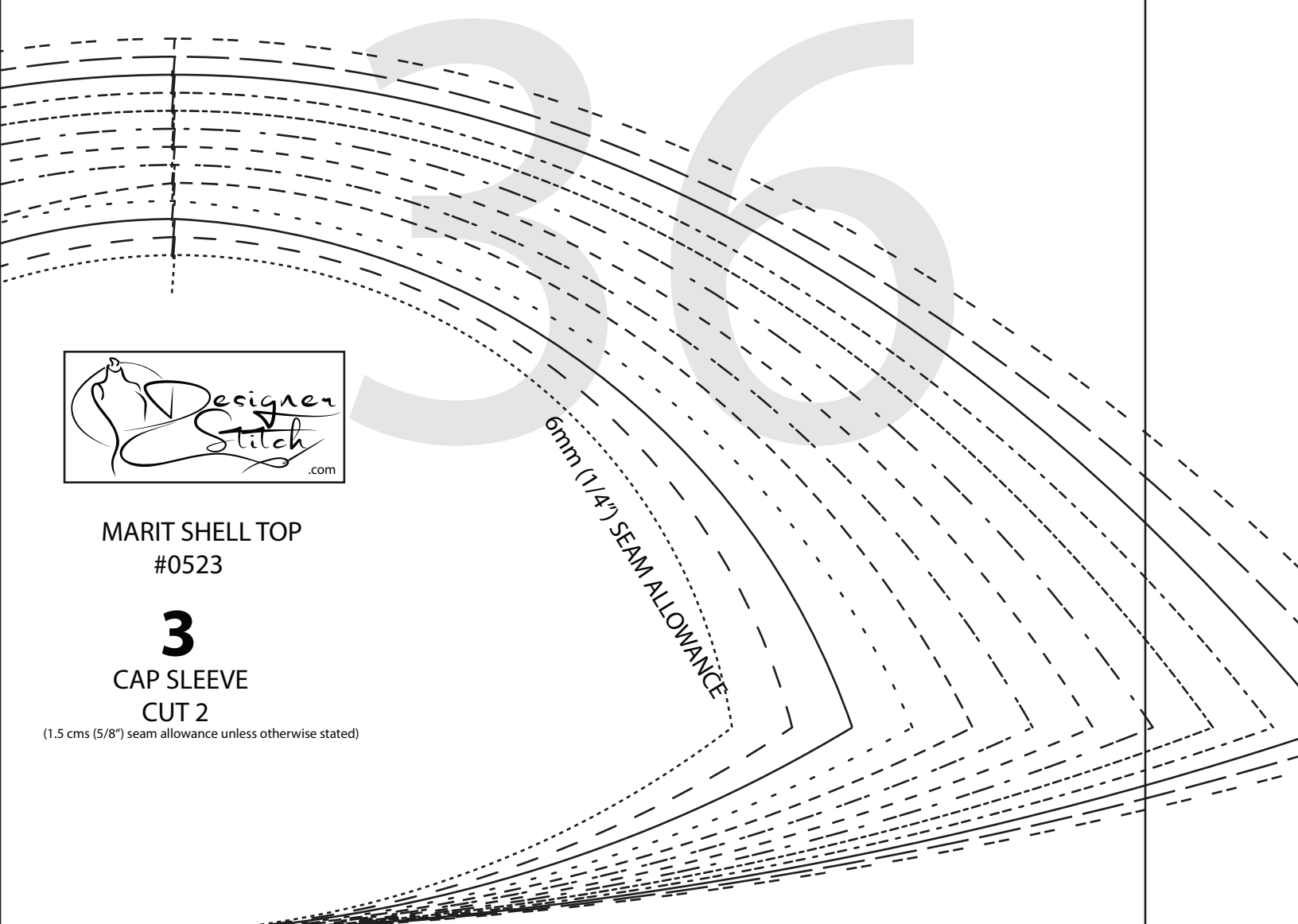

3

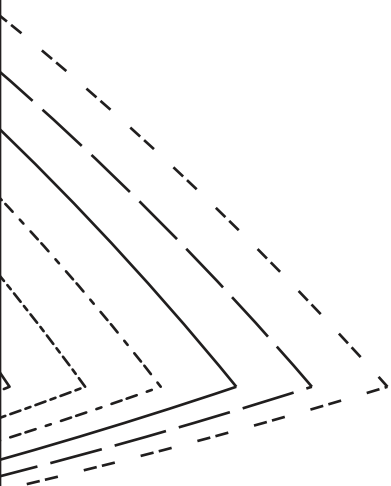

SIZE KEY

1
2	-----
3	_____
4
5	-----
6
7	-----
8	-----
9
10	-----
11	_____
12	-----
13



MARIT SHELL TOP

#0523

2

FRONT - C CUP

CUT 1 FOLD

(1.5 cms (5/8") seam allowance unless otherwise stated)

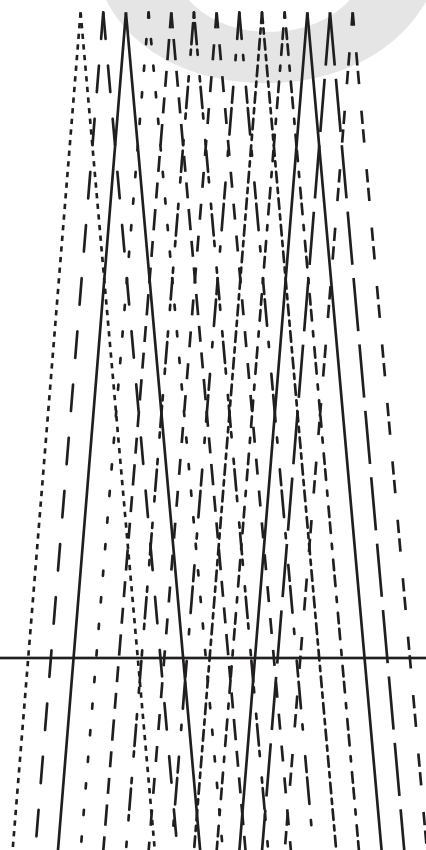

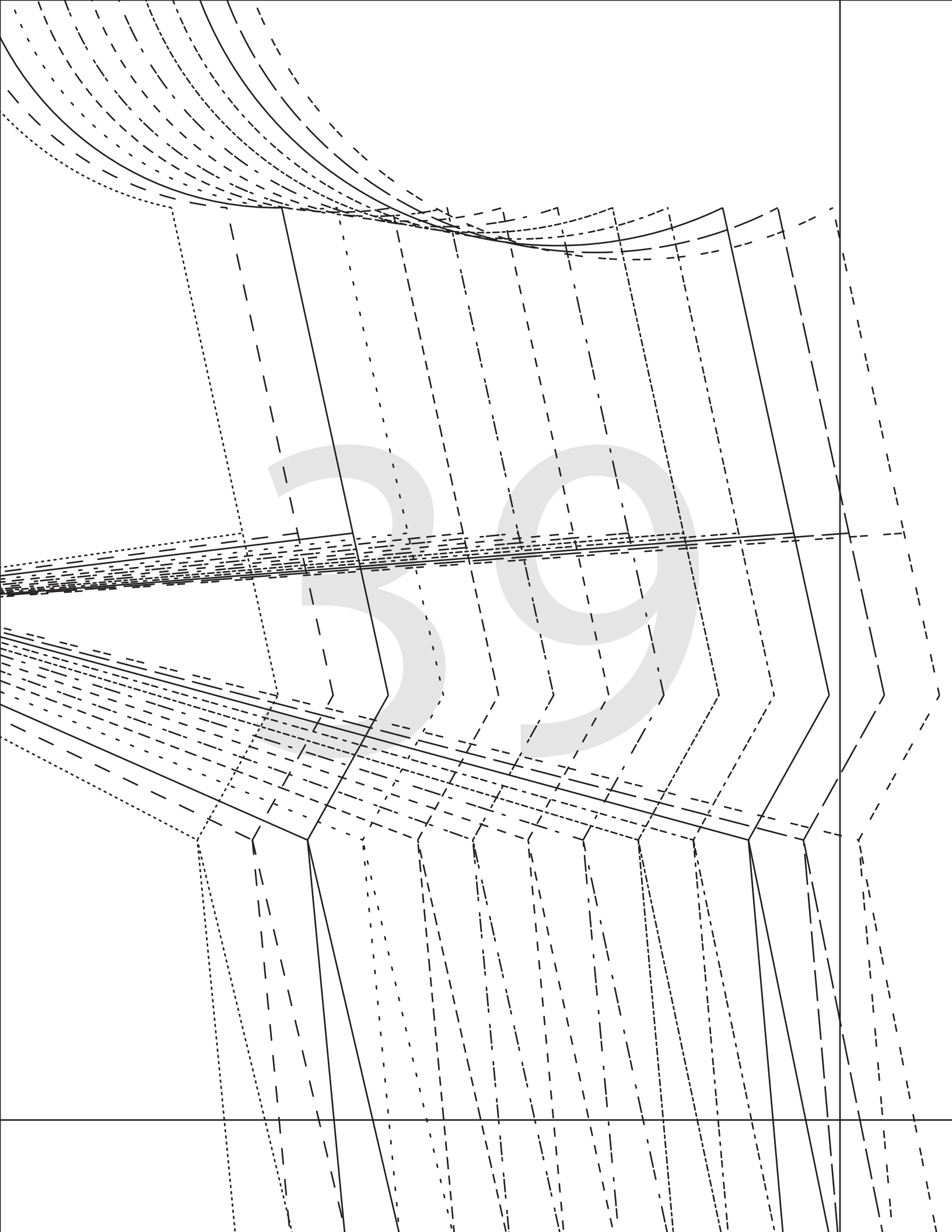

MARIT SHELL TOP

#0523

2

FRONT - D CUP

CUT 1 FOLD

(1.5 cms (5/8") seam allowance unless otherwise specified)

40

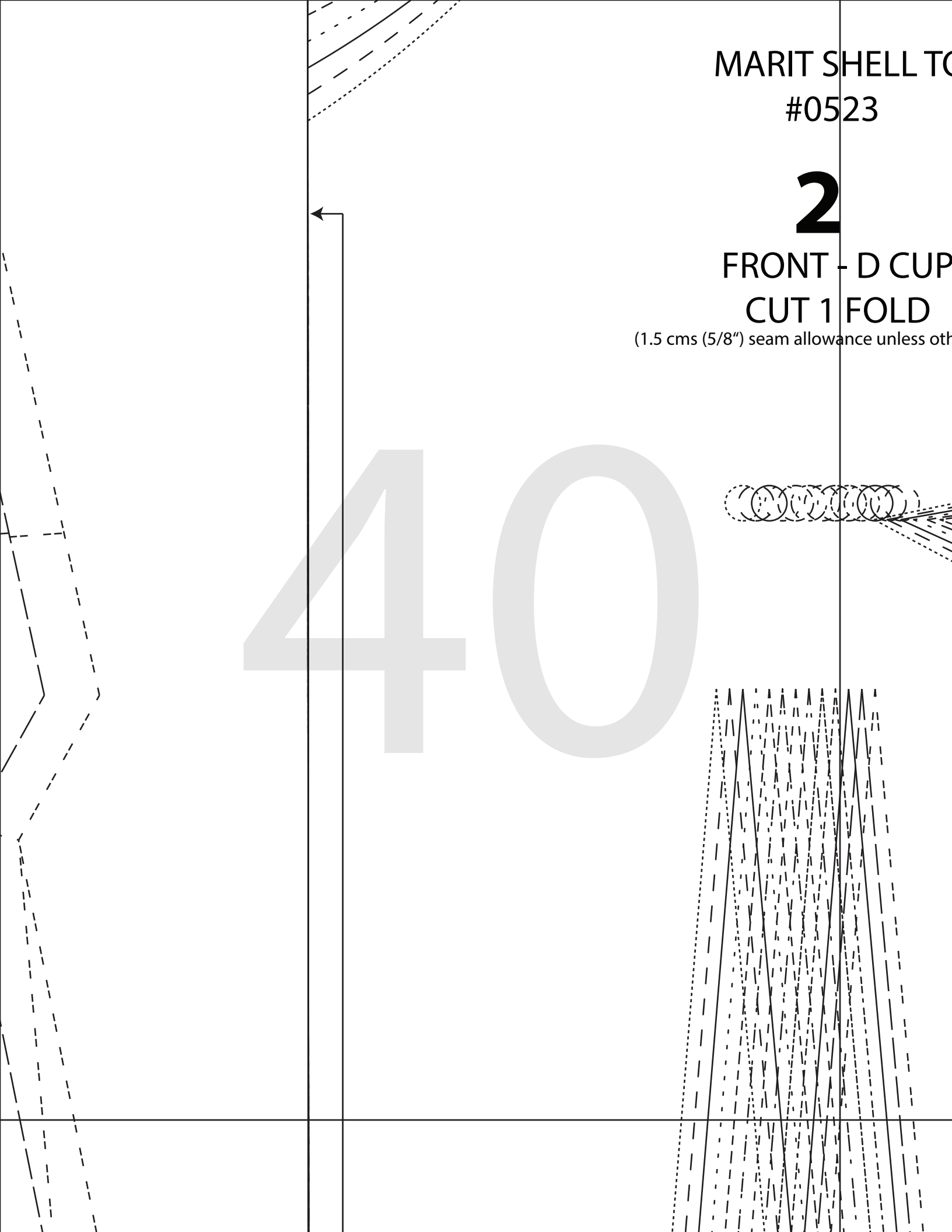
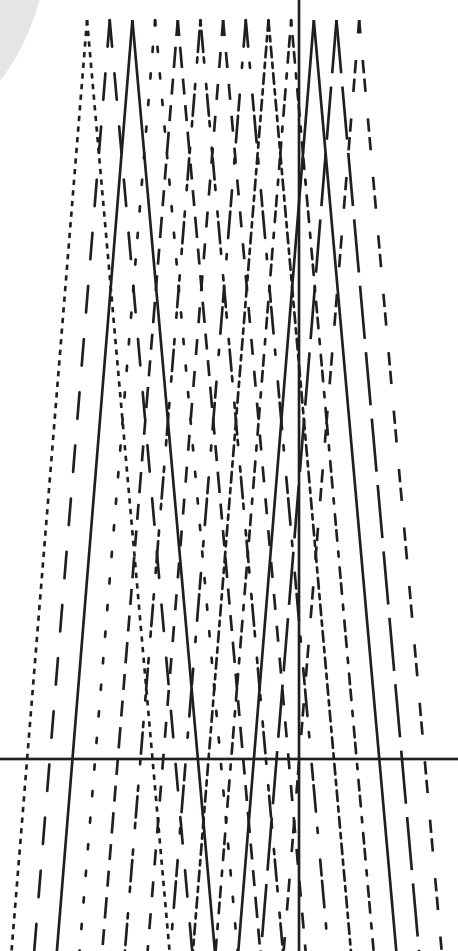
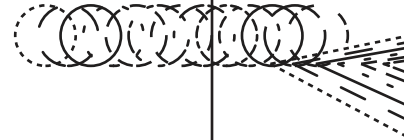

HELL TOP

23

D CUP

FOLD

(unless otherwise stated)

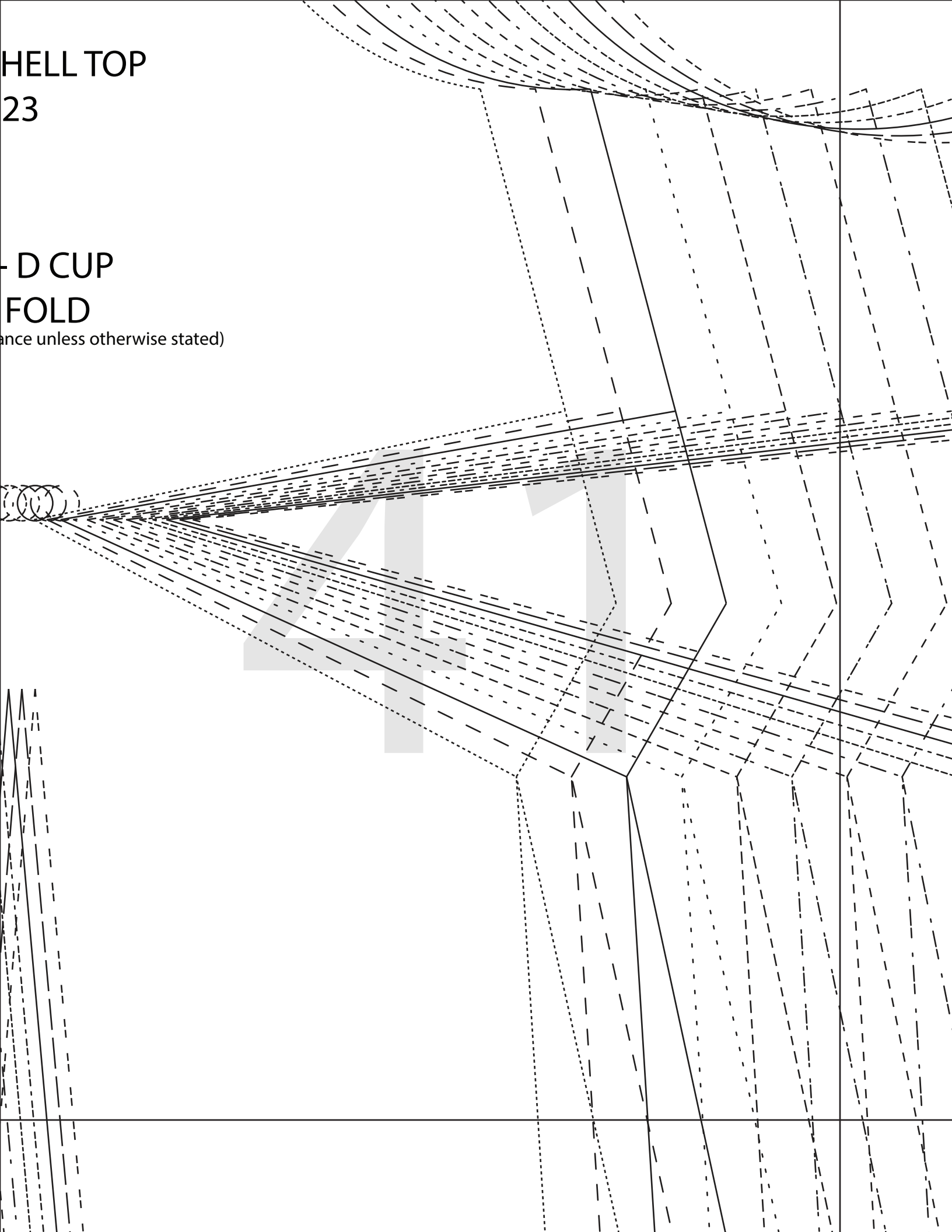

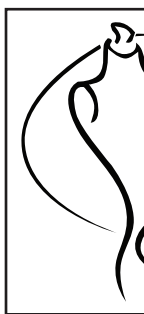
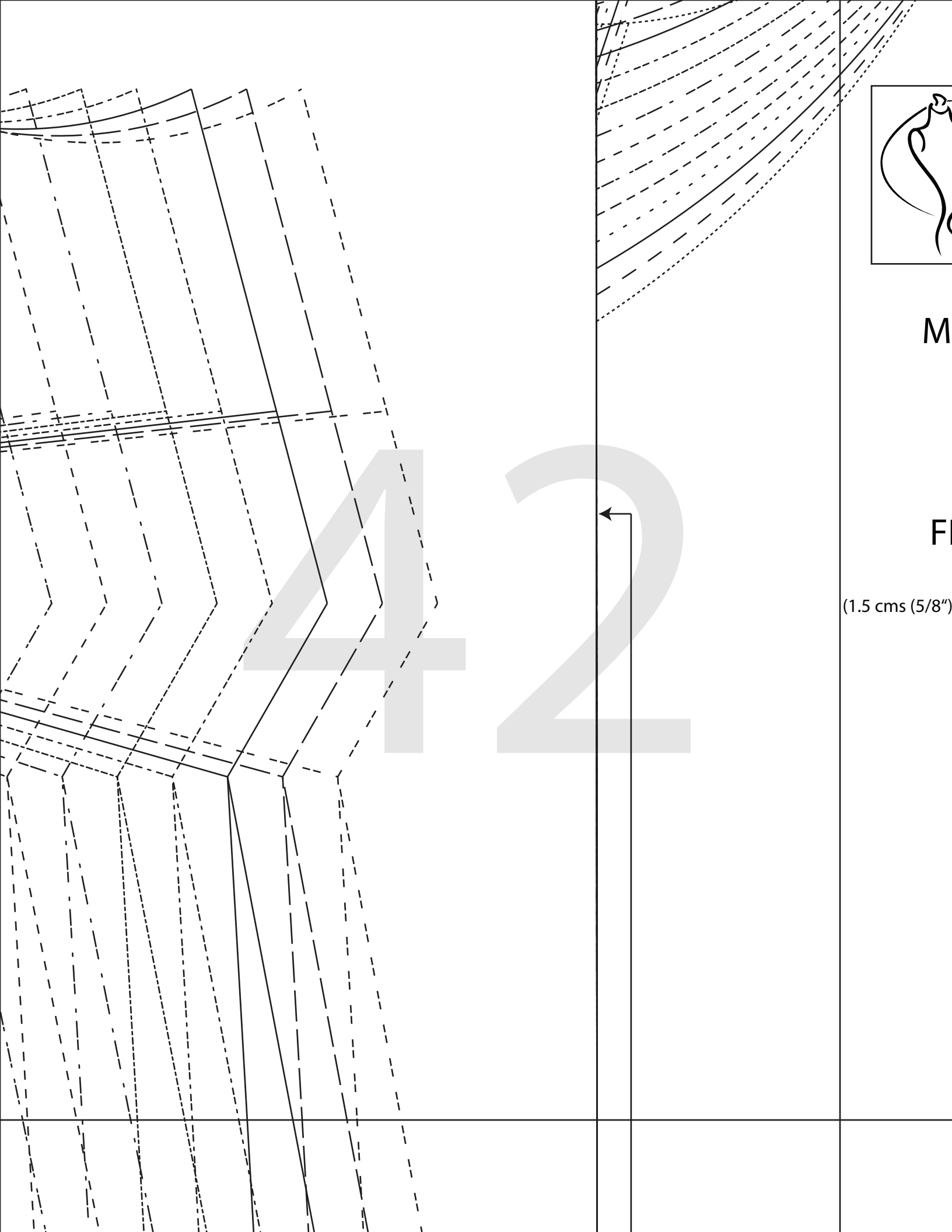

M

F

(1.5 cms (5/8"))

42



MARIT SHELL TOP

#0523

2

FRONT - DD CUP

CUT 1 FOLD

(1.5 cms (5/8") seam allowance unless otherwise stated)

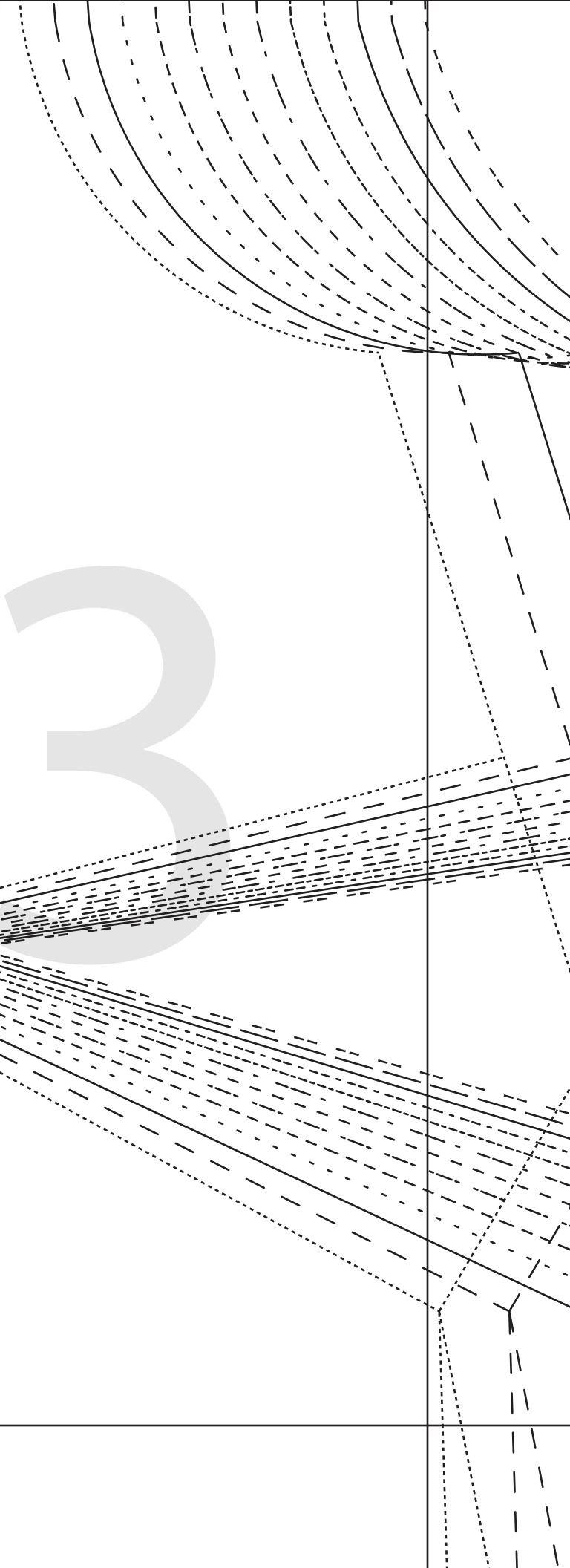
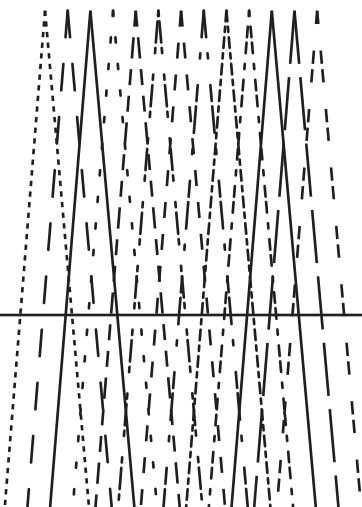

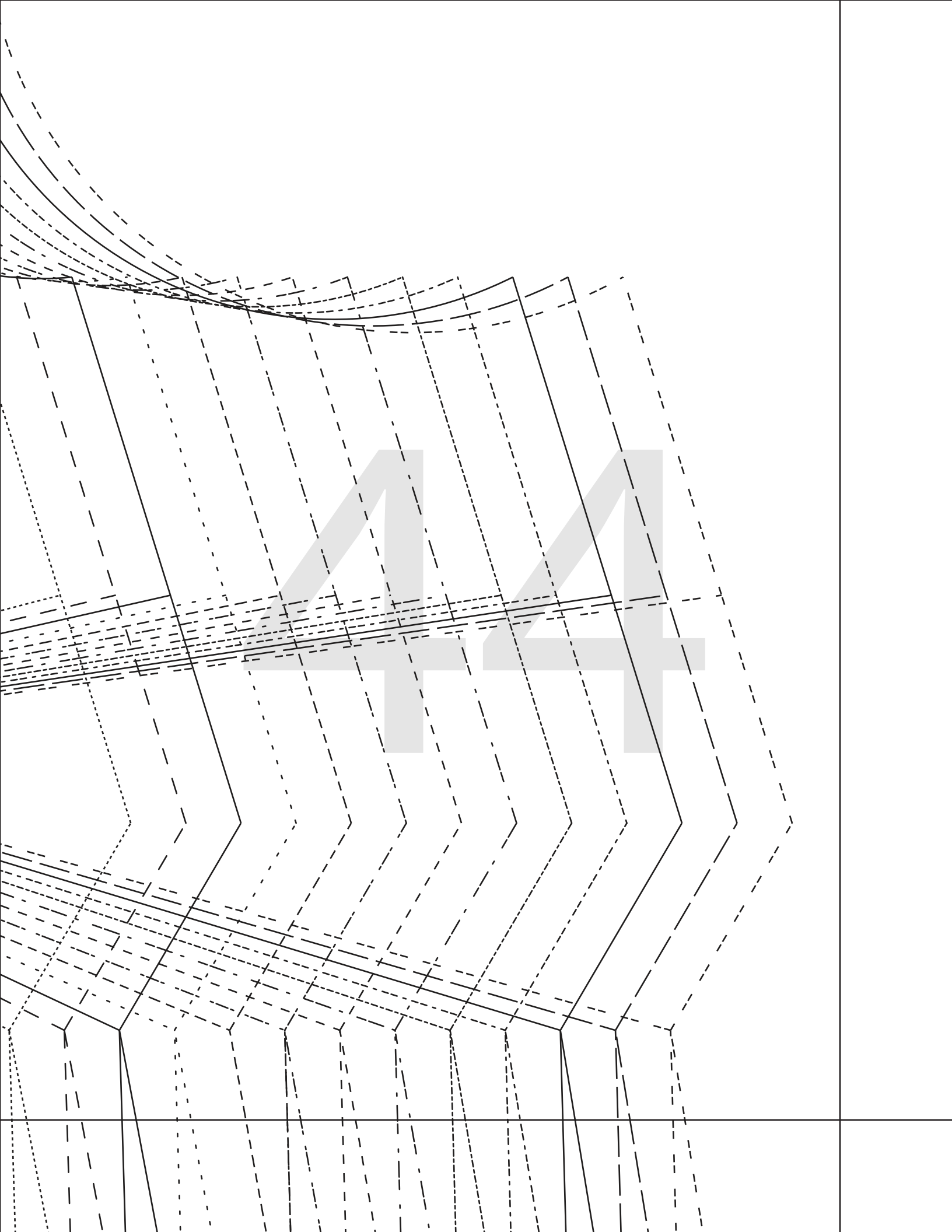

WAISTLINE

LENGTHEN/SHORTEN

2 cms (3/4") HEM ALLOWANCE

2 cms (3/4") HEM ALLOWANCE

2 cms (3/4") HEM ALLOWANCE

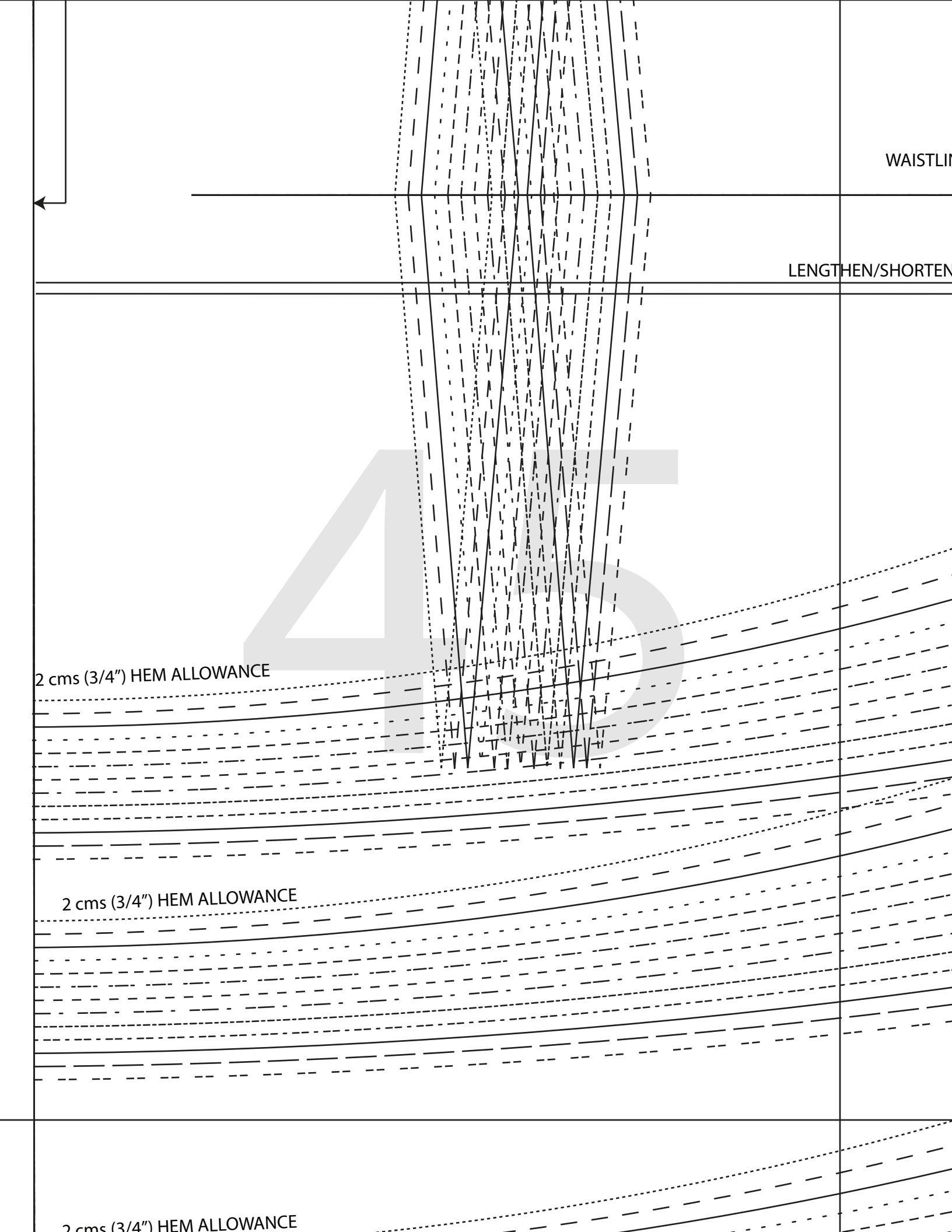
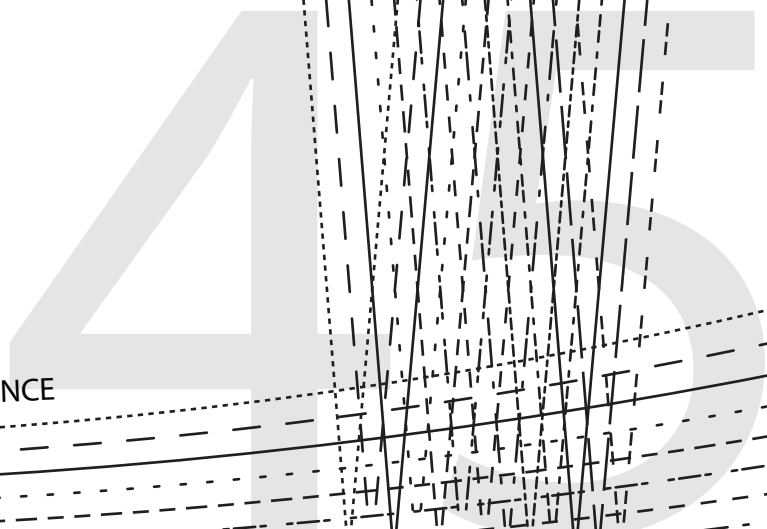

WAISTLINE

LENGTHEN/SHORTEN HERE

46

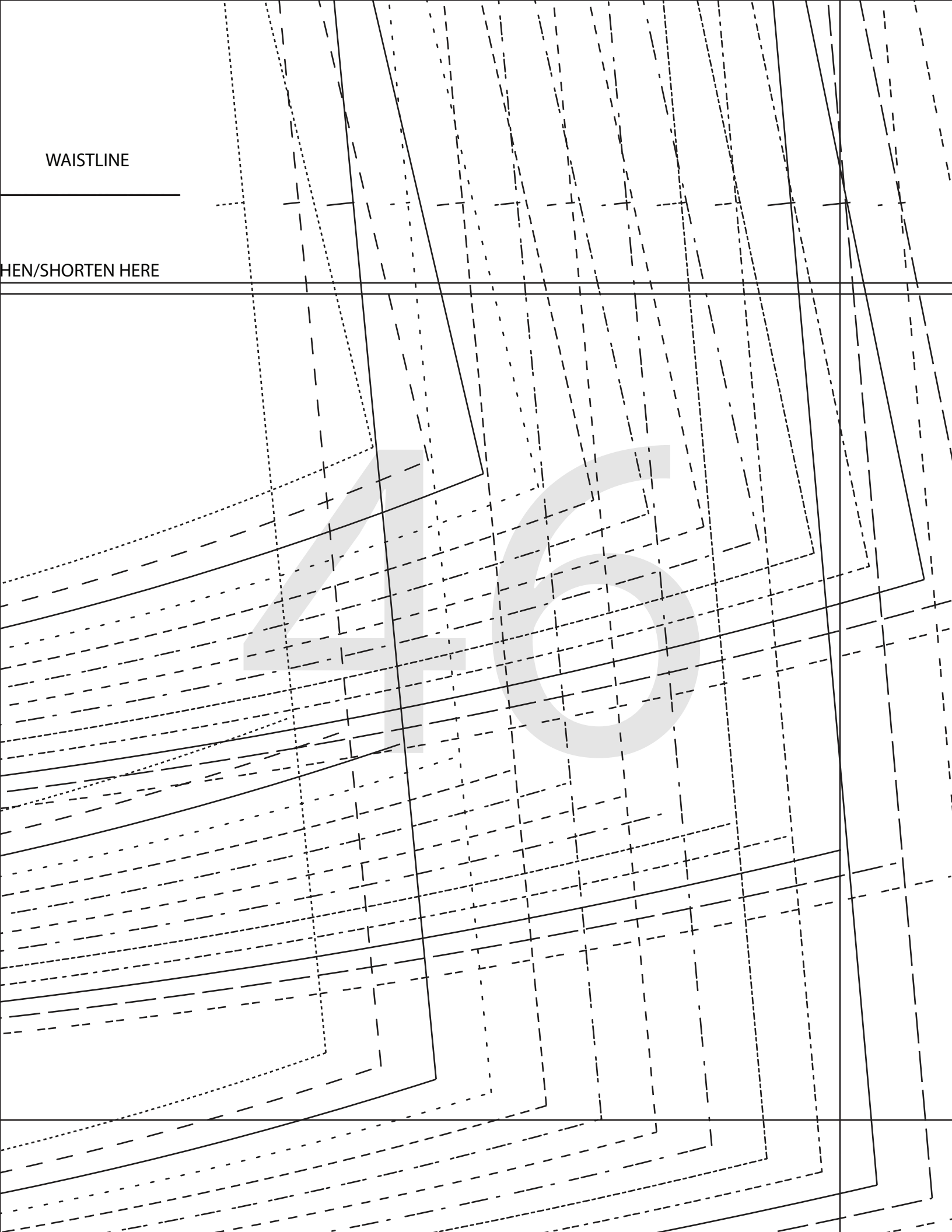

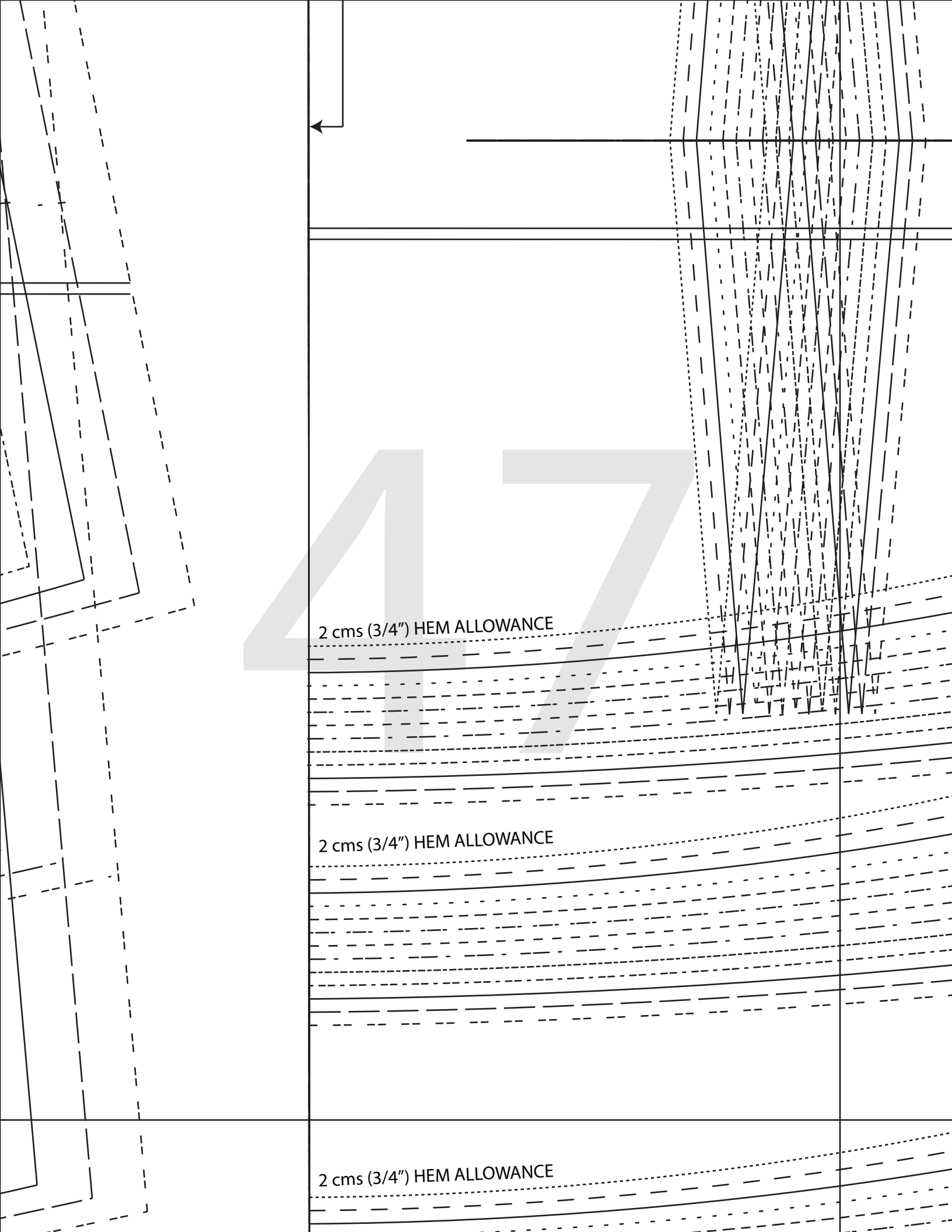

2 cms (3/4") HEM ALLOWANCE

2 cms (3/4") HEM ALLOWANCE

2 cms (3/4") HEM ALLOWANCE

WAISTLINE

LENGTHEN/SHORTEN HERE

48

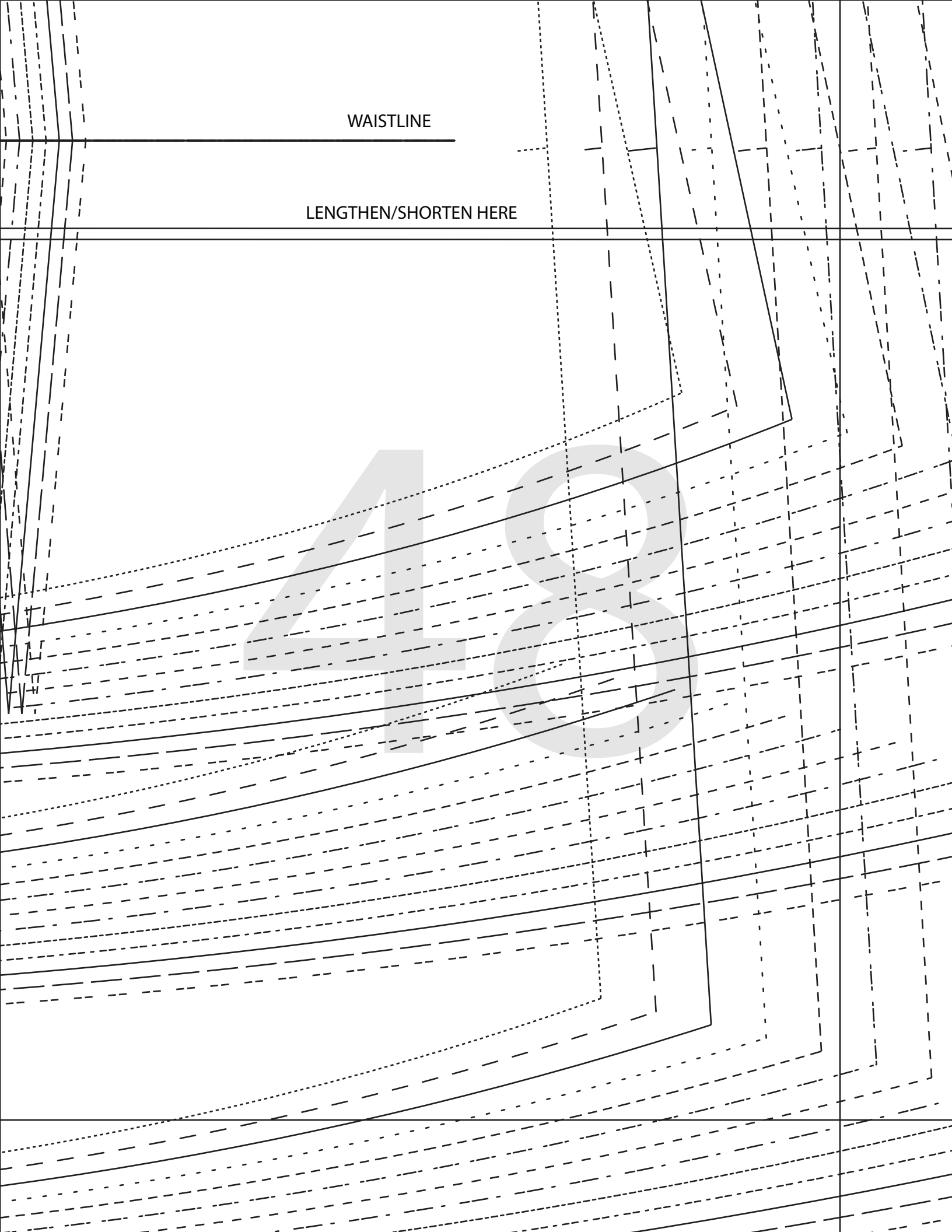

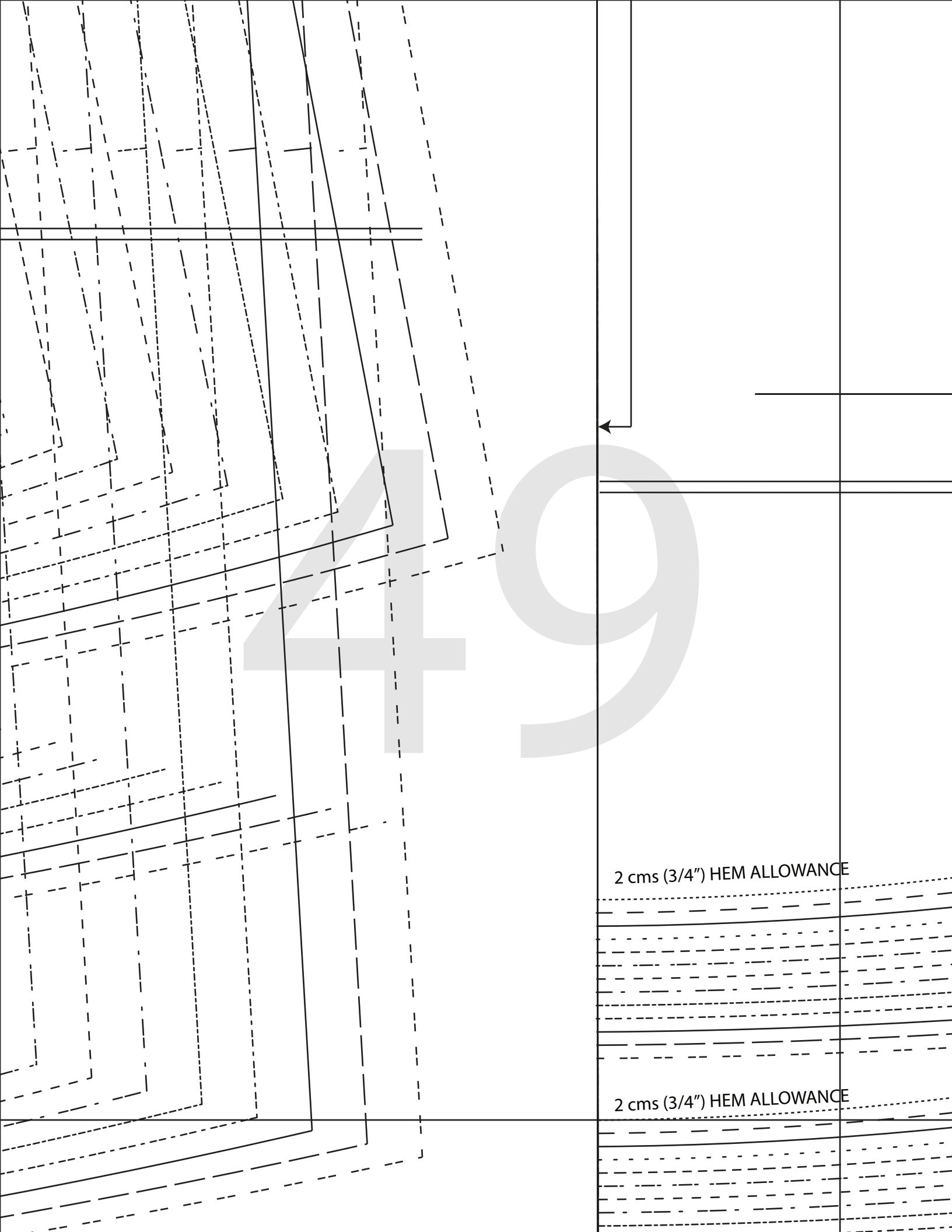

2 cms (3/4") HEM ALLOWANCE

2 cms (3/4") HEM ALLOWANCE

WAISTLINE

LENGTHEN/SHORTEN HERE

50

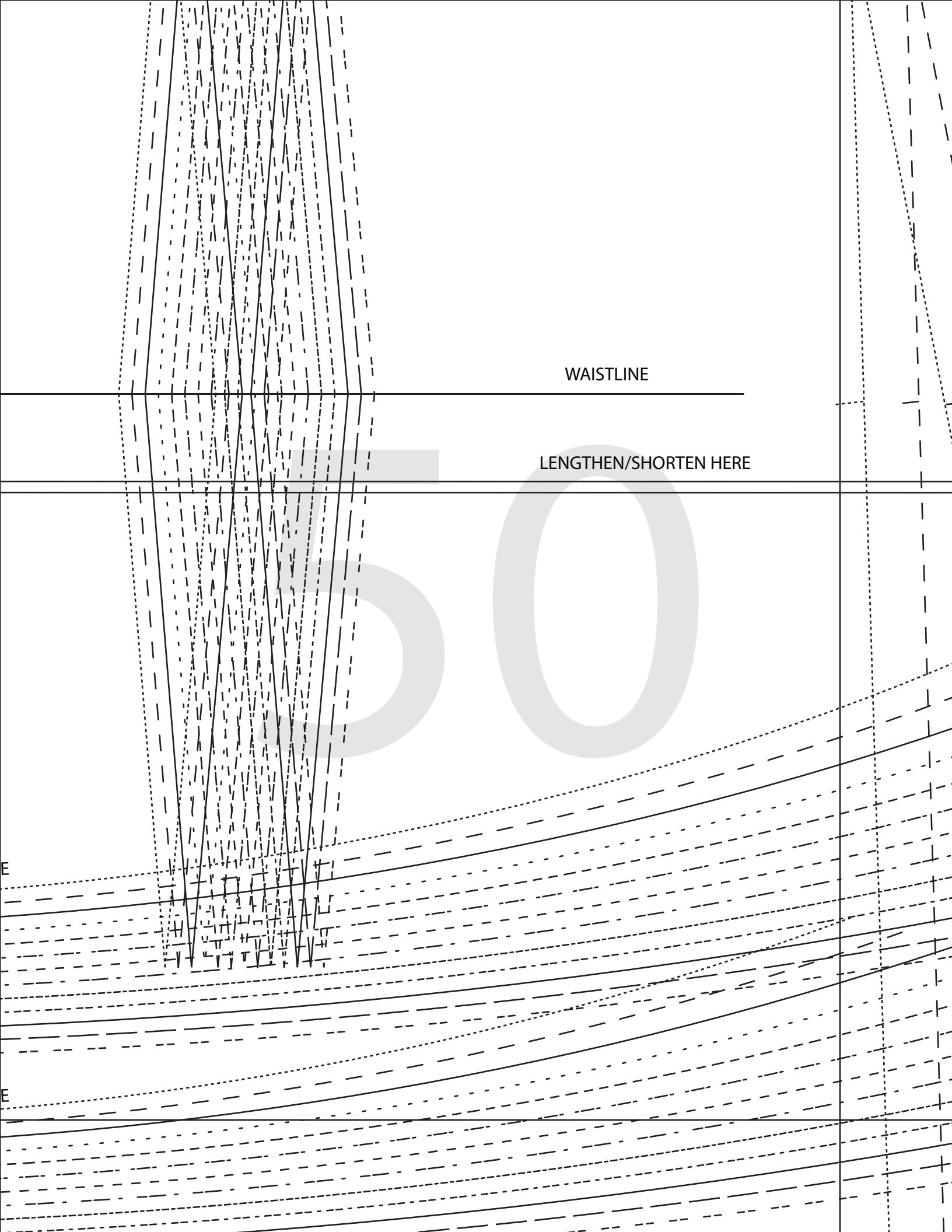

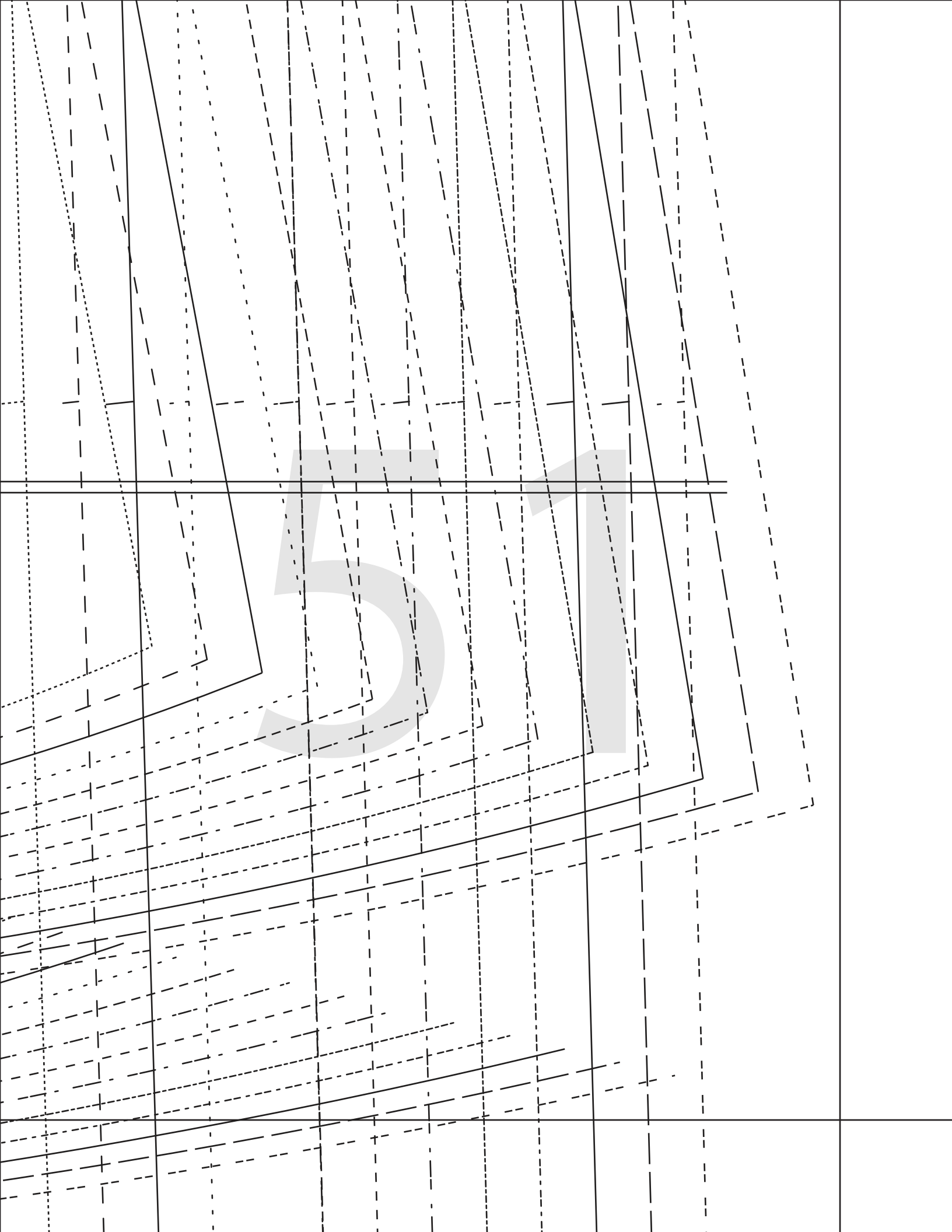

2 cms (3/4") HEM ALLOWANCE

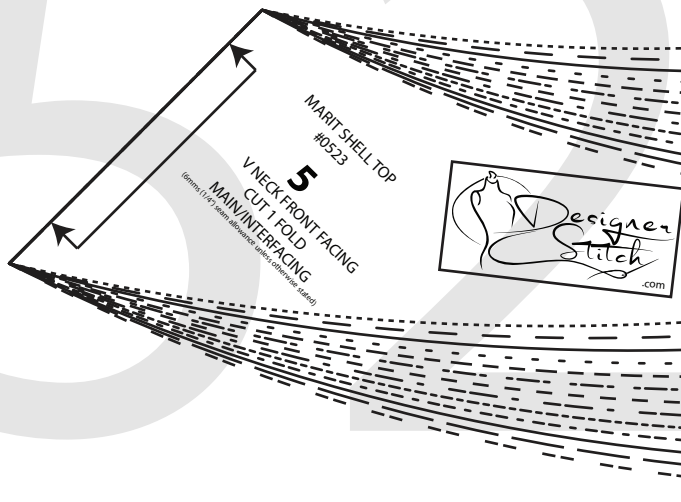

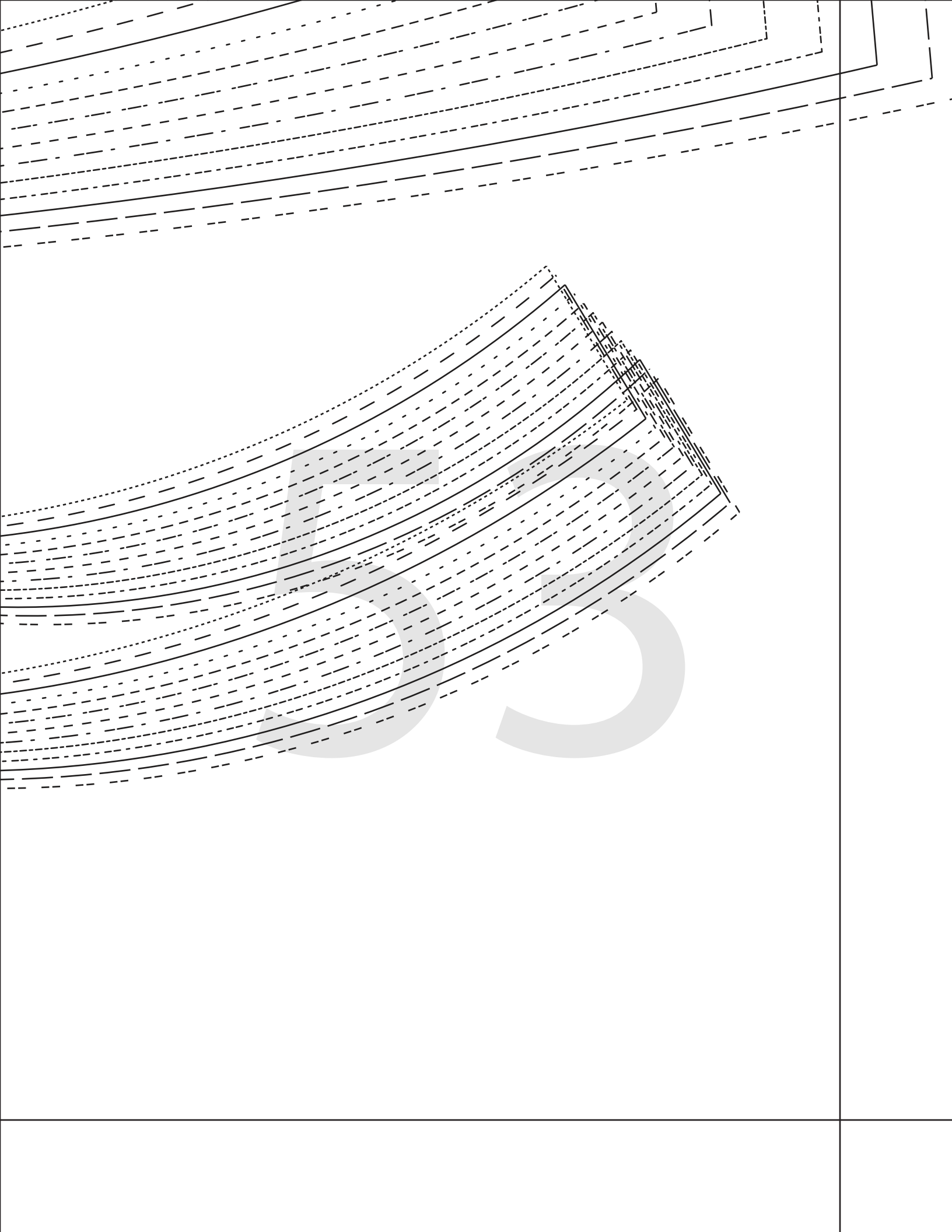

2 cms (3/4") HEM ALLOWANCE

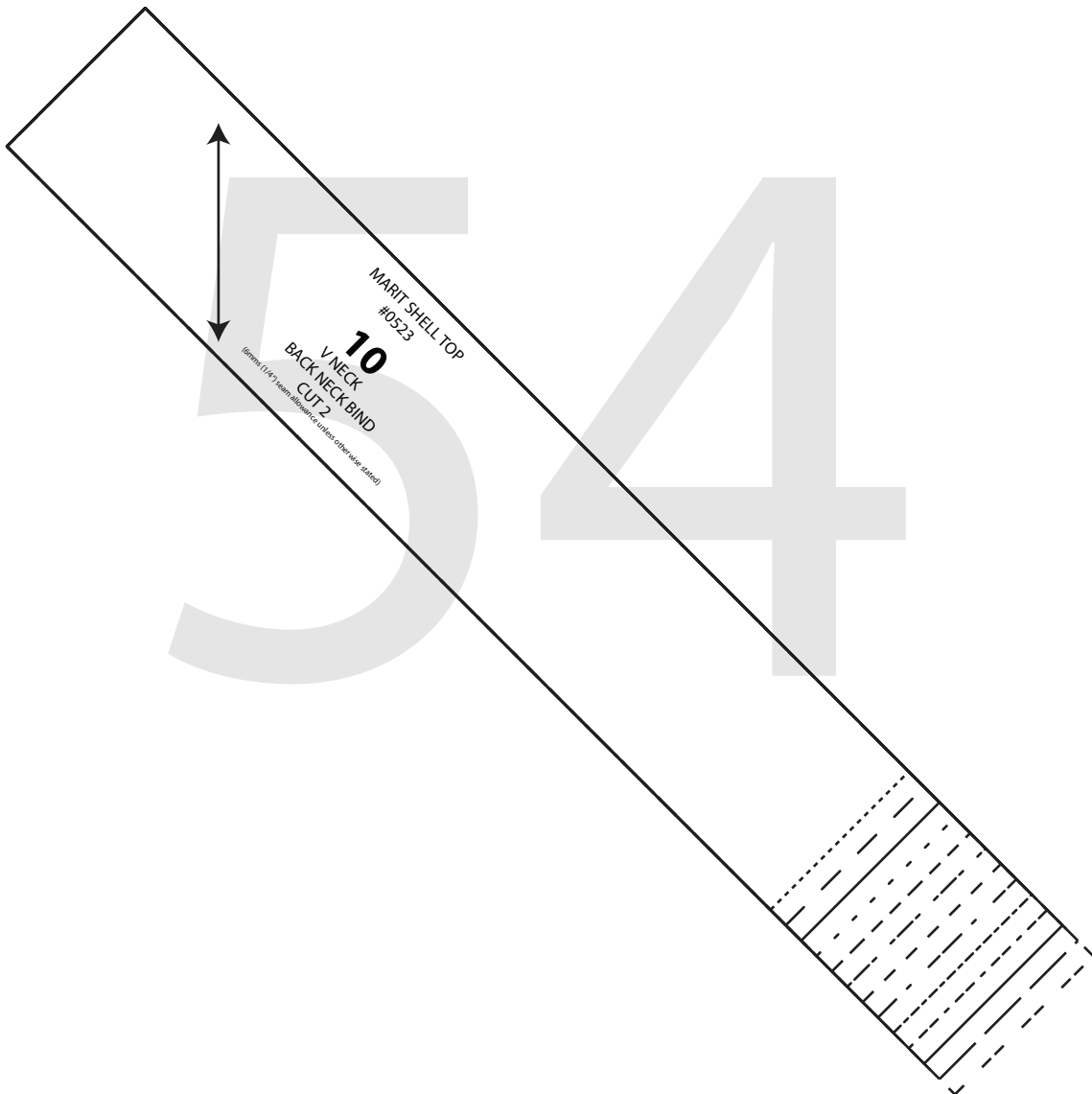
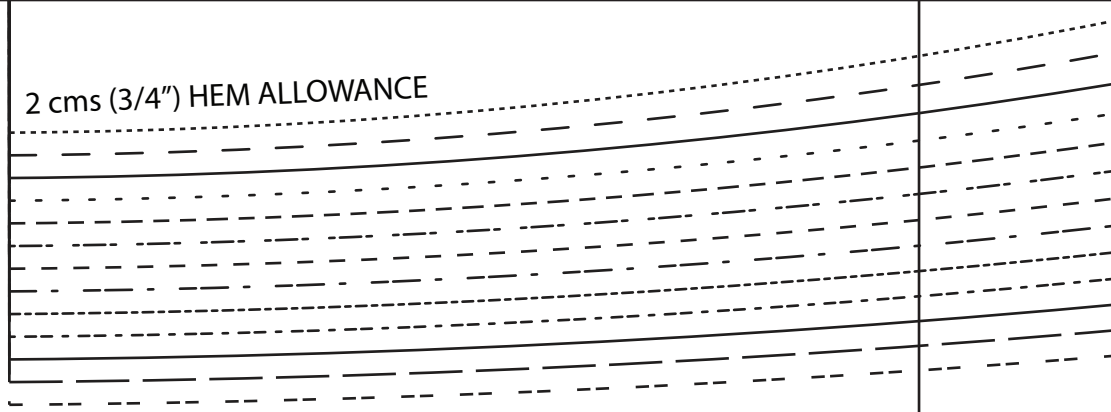

MARIT SHELL TOP
#0523

10
V NECK
BACK NECK BIND
CUT 2

<http://www.1001patterns.com>

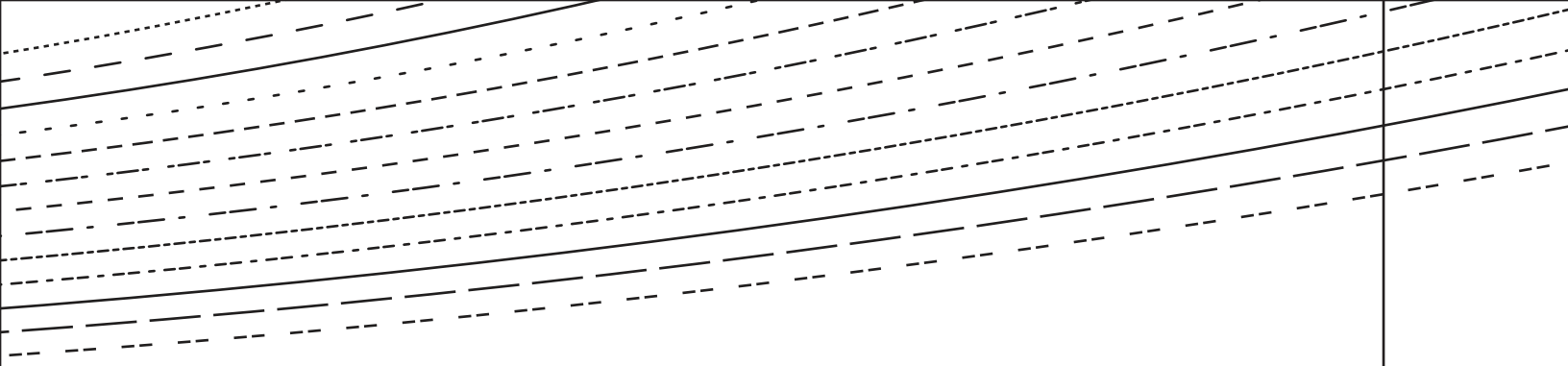

55

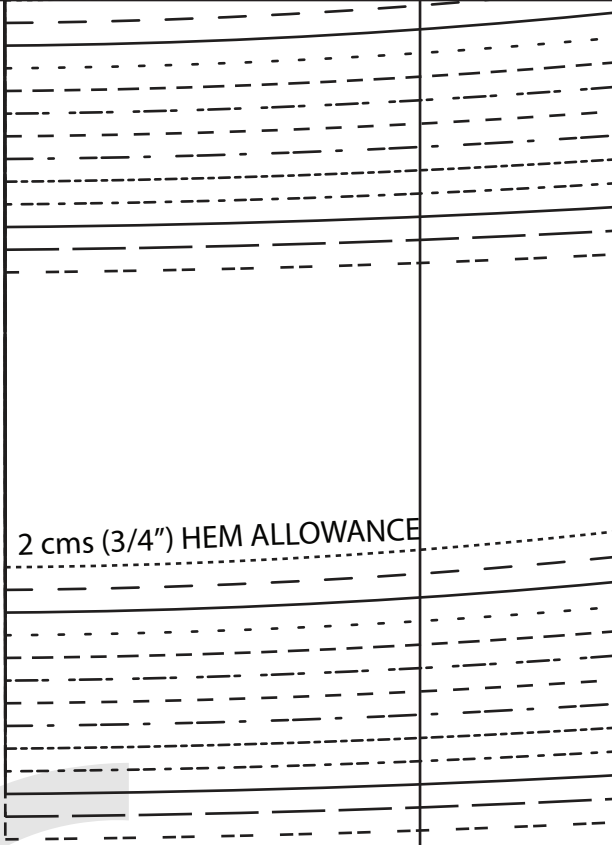
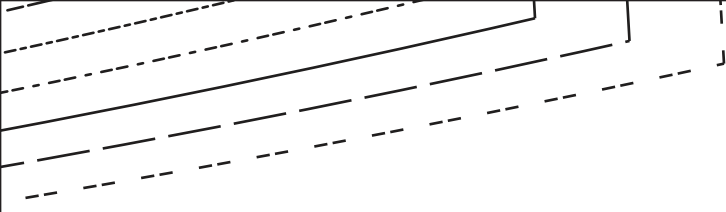

2 cms (3/4") HEM ALLOWANCE

56

57

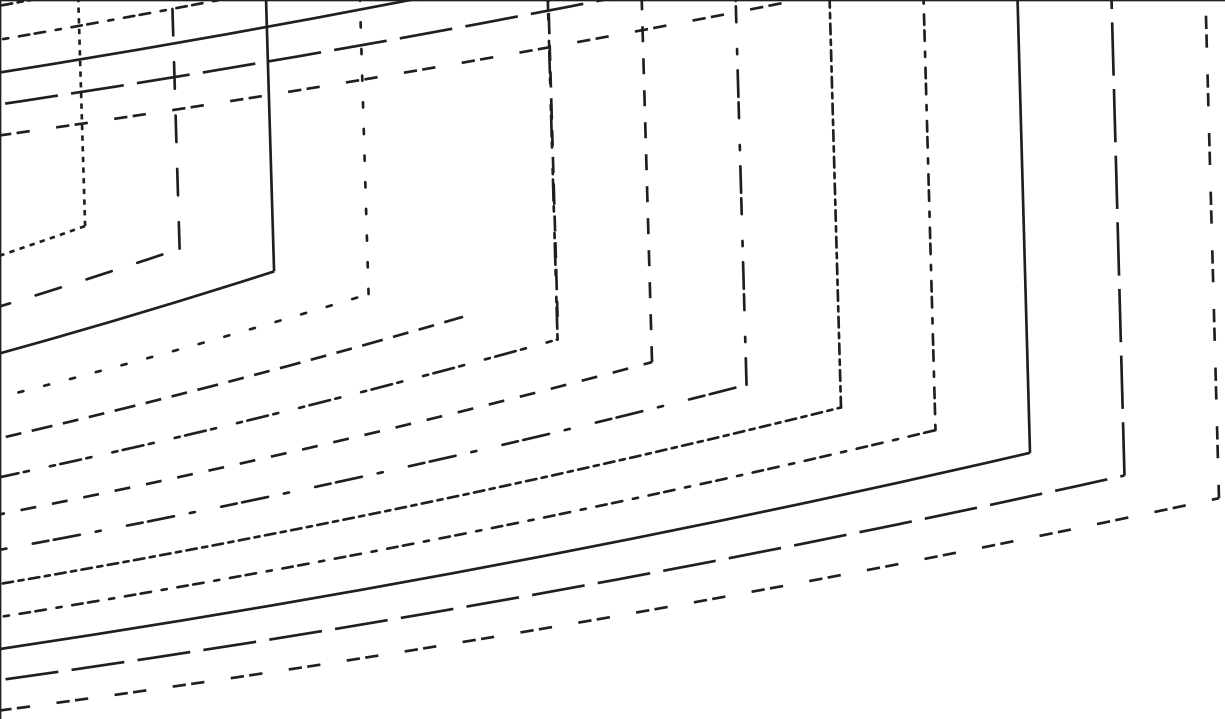

58