

PRINT TILING TEMPLATE GUIDE FOR SIZE SPECIFIC CHOICE
 TRIM PRINT AT HOME PATTERN

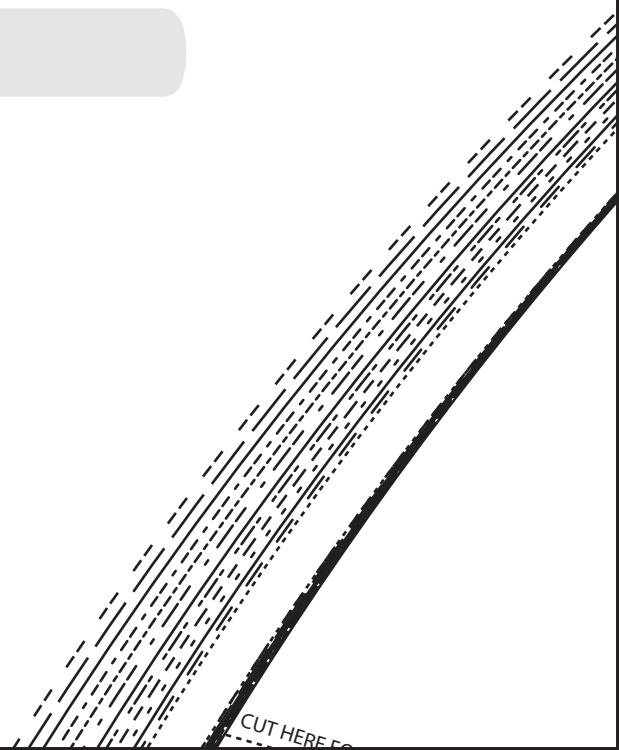

YASMINE WRAP DRESS

#0723

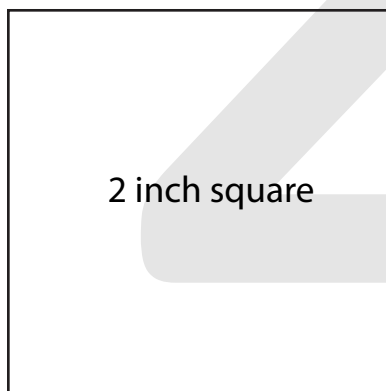
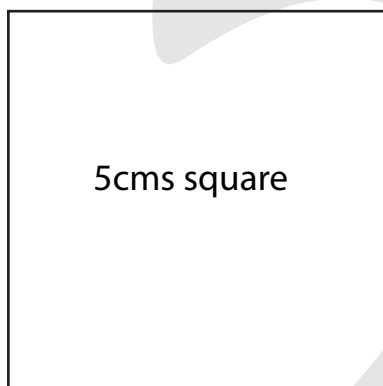

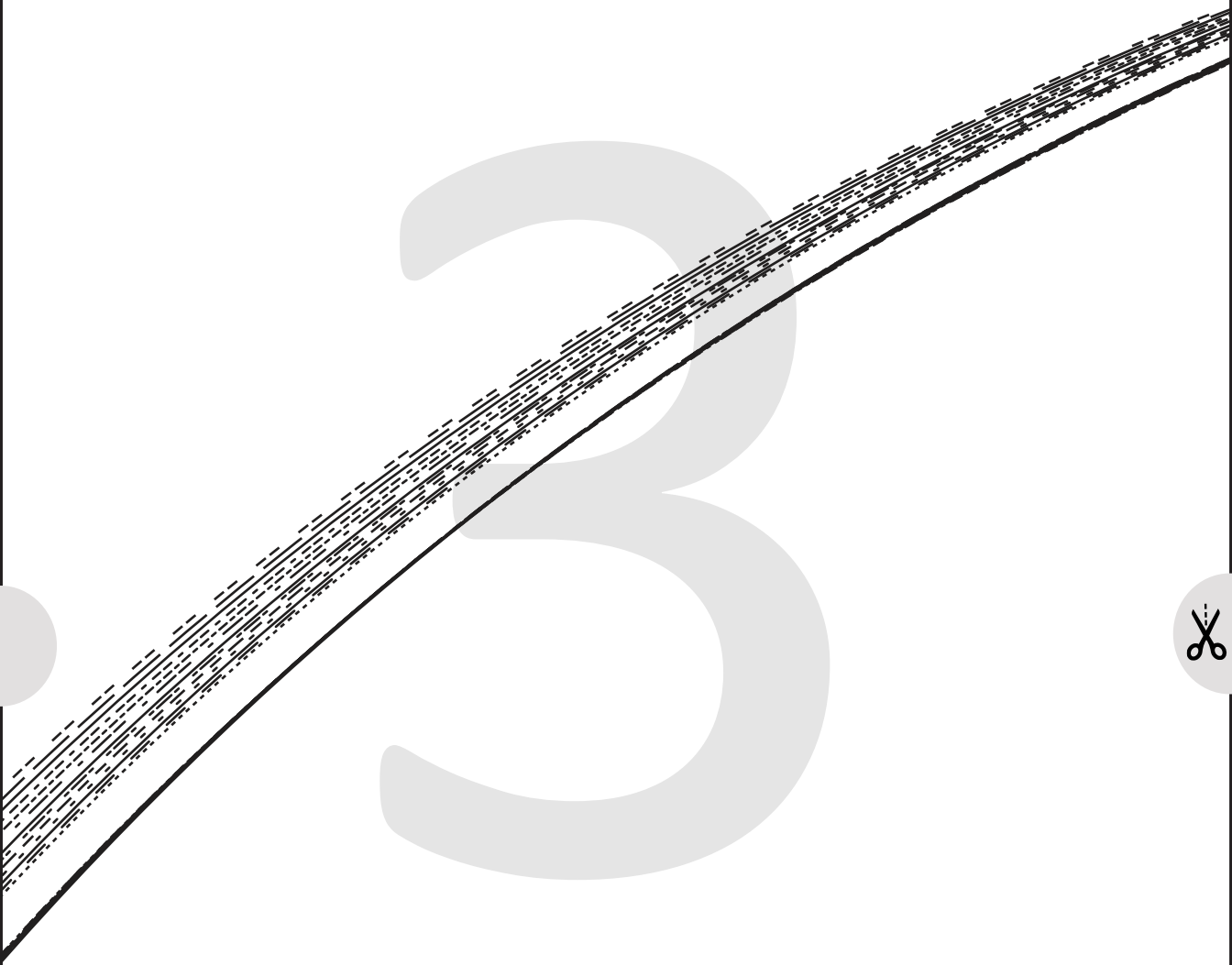

4

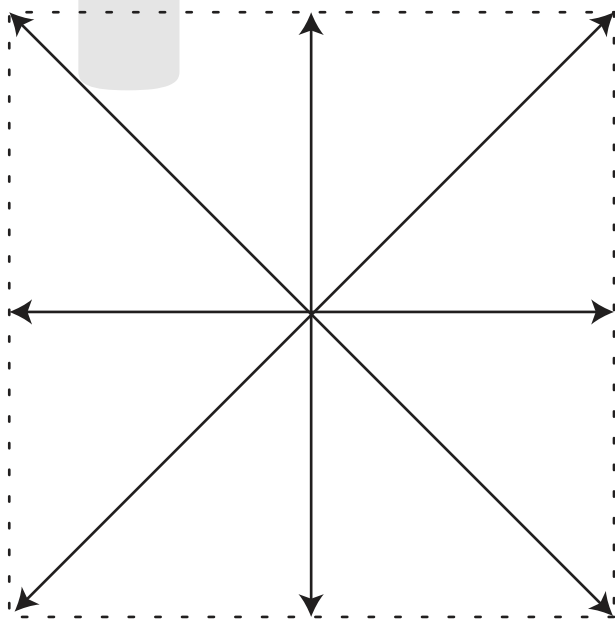

YASMIN WRAP DRESS

#0723

6

FRONT FLOUNCE

CUT 2

(1.5 cms (5/8") seam allowance unless otherwise stated)



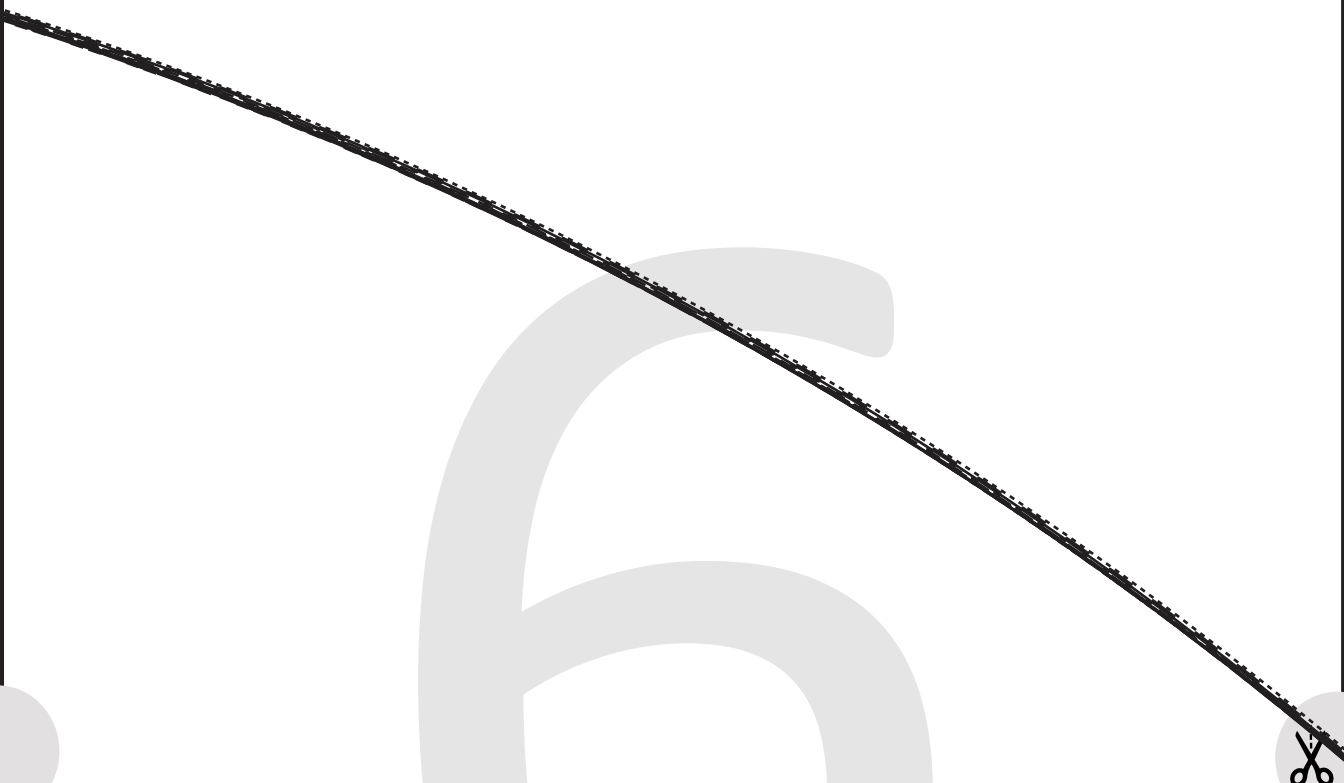

6



SIZE KEY

1

2 - - - - -

3 _____

4



5 - - - - -

6

7 - - - - -

8 - - - - -

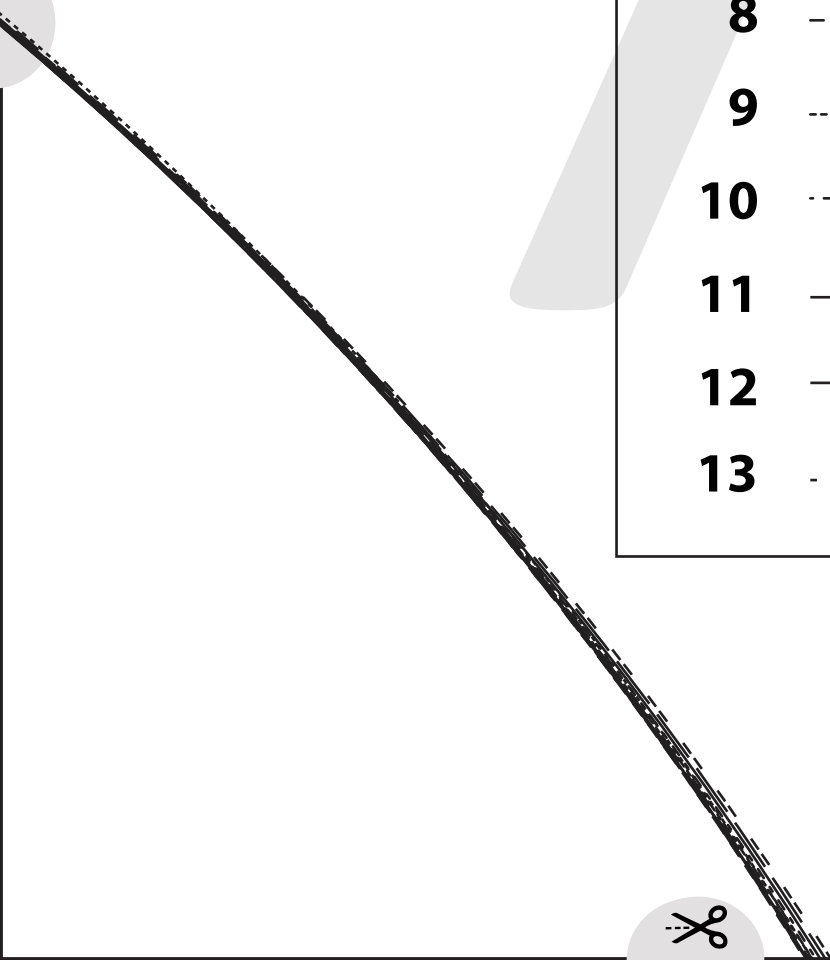
9

10

11 _____

12 - - - - -

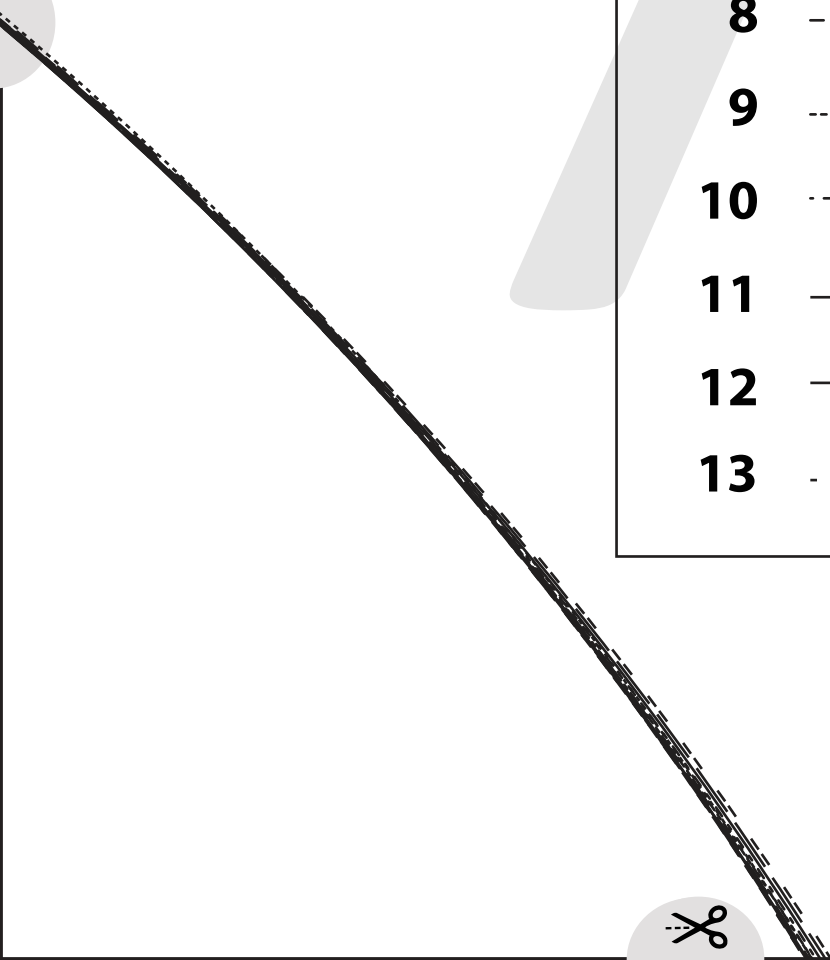
13

SIDE SEAM

SIDE SEAM

SIDE SEAM

SIDE SEAM

SIDE SEAM

SIDE SEAM

SIDE SEAM

SIDE SEAM

SIDE SEAM

SIDE SEAM

SIDE SEAM

SIDE SEAM

SIDE SEAM



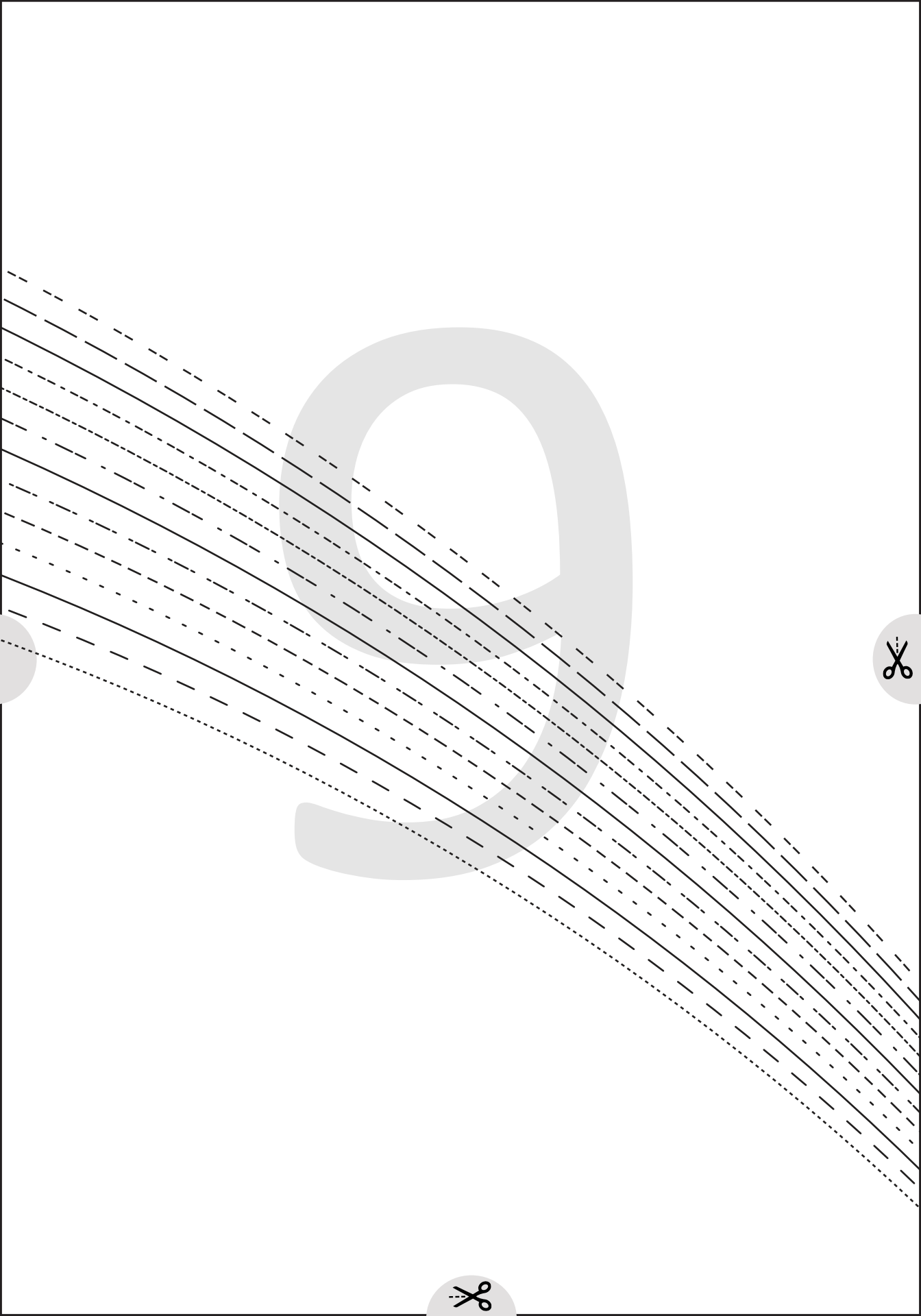

10

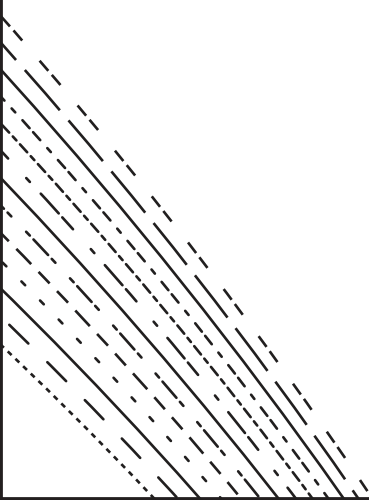

CUT HERE FOR 55 cms (21 3/4")

CUT HERE FOR 55 cms (21 3/4")

CUT HERE FOR 55 cms (21 3/4")

CUT HERE FOR 55 cms (21 3/4")

CUT HERE FOR 60Cms (23 1/2")

CUT HERE FOR 55 cms (21 3/4")

CUT HERE FOR 60Cms (23 1/2")

CUT HERE FOR 55 cms (21 3/4")

CUT HERE FOR 60Cms (23 1/2")

CUT HERE FOR 55 cms (21 3/4")

CUT HERE FOR 60Cms (23 1/2")

CUT HERE FOR 55 cms (21 3/4")

CUT HERE FOR 60Cms (23 1/2")

CUT HERE FOR 55 cms (21 3/4")

CUT HERE FOR 60Cms (23 1/2")

CUT HERE FOR 55 cms (21 3/4")

CUT HERE FOR 60Cms (23 1/2")

CUT HERE FOR 55 cms (21 3/4")

CUT HERE FOR 60Cms (23 1/2")

CUT HERE FOR 55 cms (21 3/4")

CUT HERE FOR 60Cms (23 1/2")

CUT HERE FOR 55 cms (21 3/4")

CUT HERE FOR 60Cms (23 1/2")

CUT HERE FOR 55 cms (21 3/4")

CUT HERE FOR 60Cms (23 1/2")

CUT HERE FOR 75 cms (29 1/2")

CUT HERE FOR 60Cms (23 1/2")

CUT HERE FOR 60Cms (23 1/2")

CUT HERE FOR 75 cms (29 1/2")

CUT HERE FOR 75 cms (29 1/2")

CUT HERE FOR 75 cms (29 1/2")

CUT HERE FOR 75 cms (29 1/2")

CUT HERE FOR 75 cms (29 1/2")

CUT HERE FOR 75 cms (29 1/2")

CUT HERE FOR 75 cms (29 1/2")



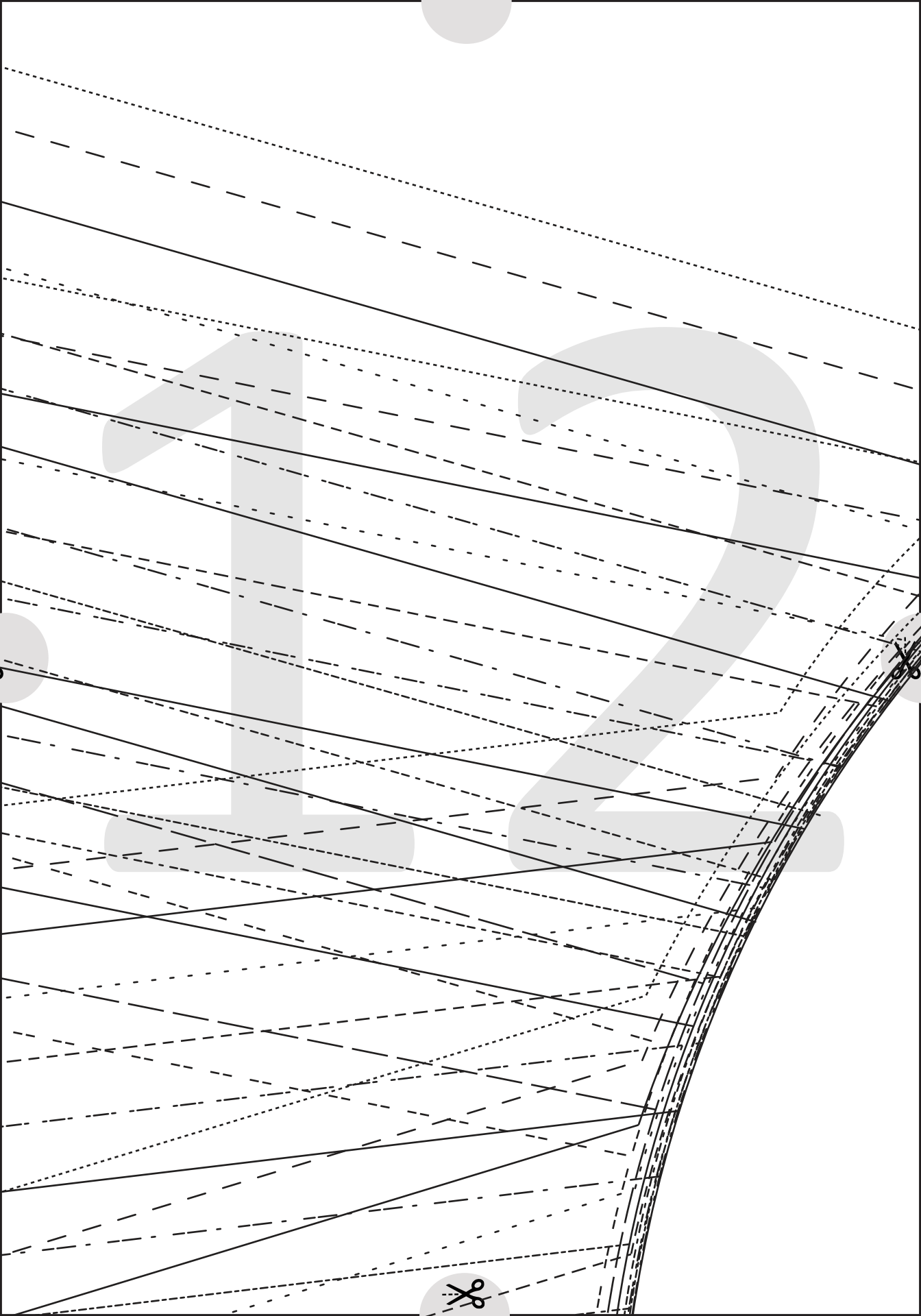

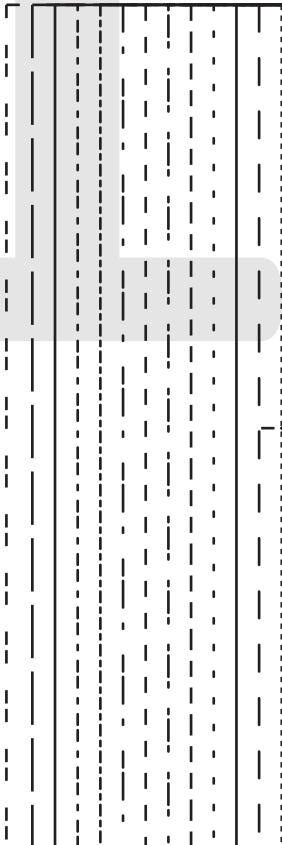

YASMIN WRAP DRESS
#0723

10
CUFF

CUT 2 - MAIN/INTERFACI
(1.5 cms (5/8") seam allowance unless otherwise s



1 cms (3/8") SEAM ALLOWANCE



er
h
.com

NG
(ated)



15

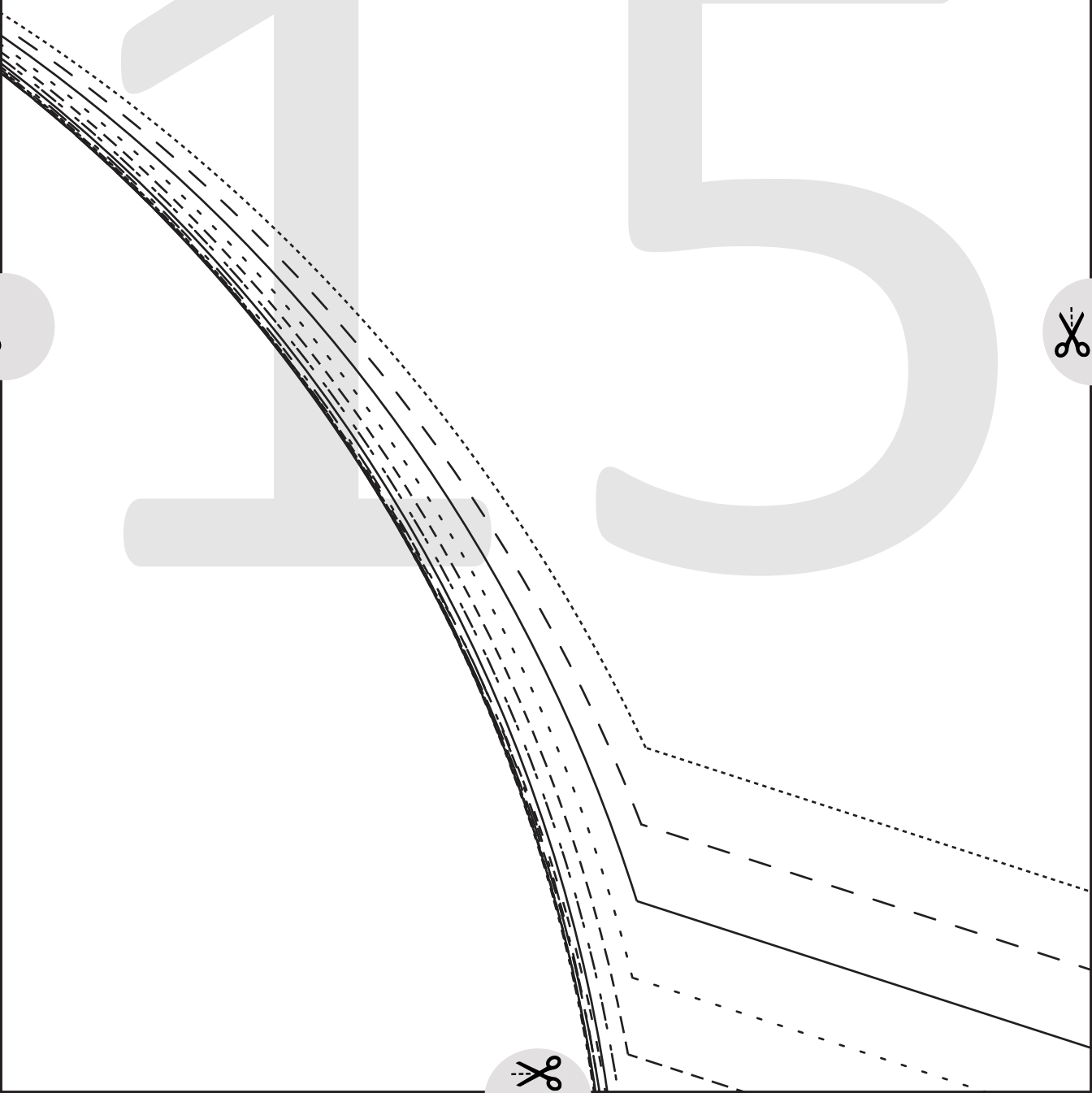

1

6



1

7



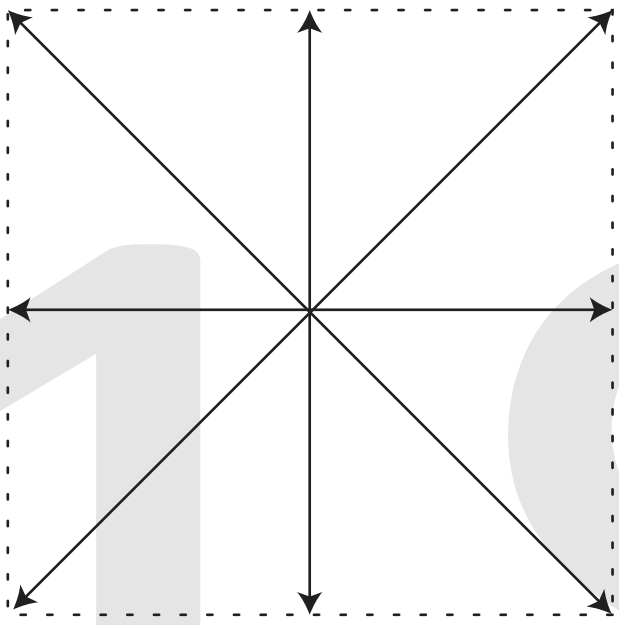
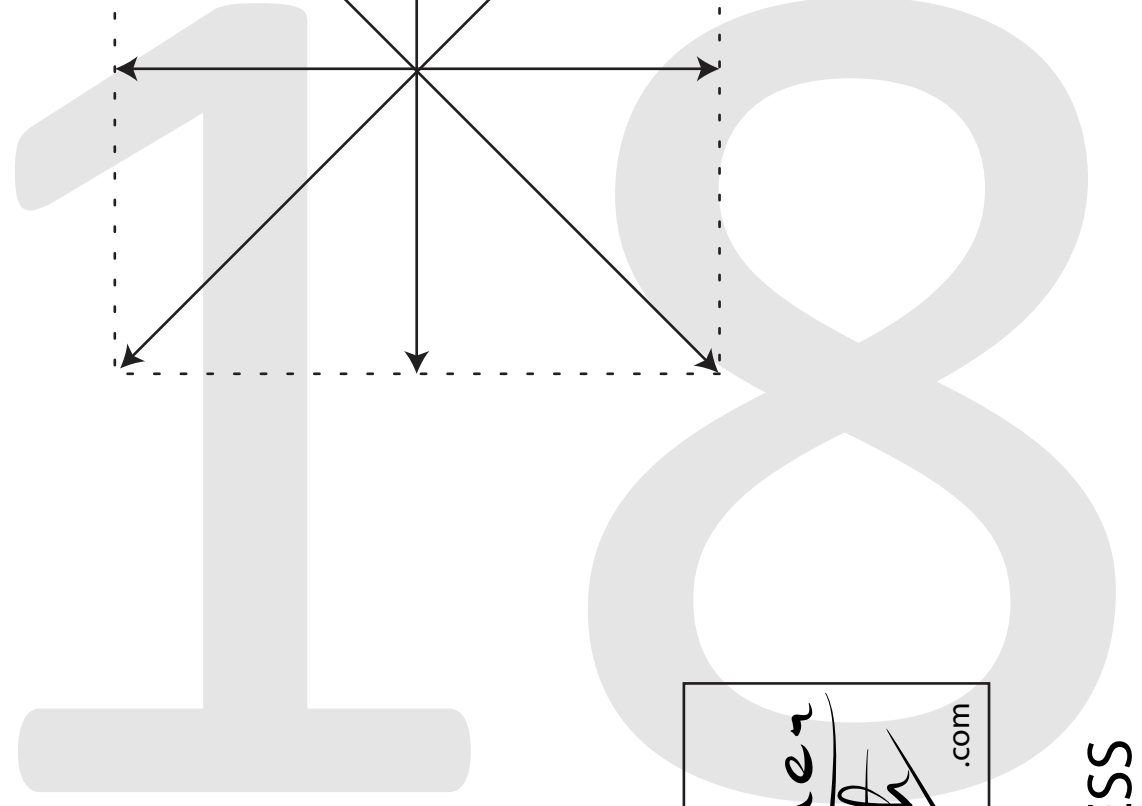

YASMIN WRAP DRESS

#0723



5

BACK FLOUNCE

CUT 1 FOLD

(1.5 cms (5/8") seam allowance unless otherwise stated)

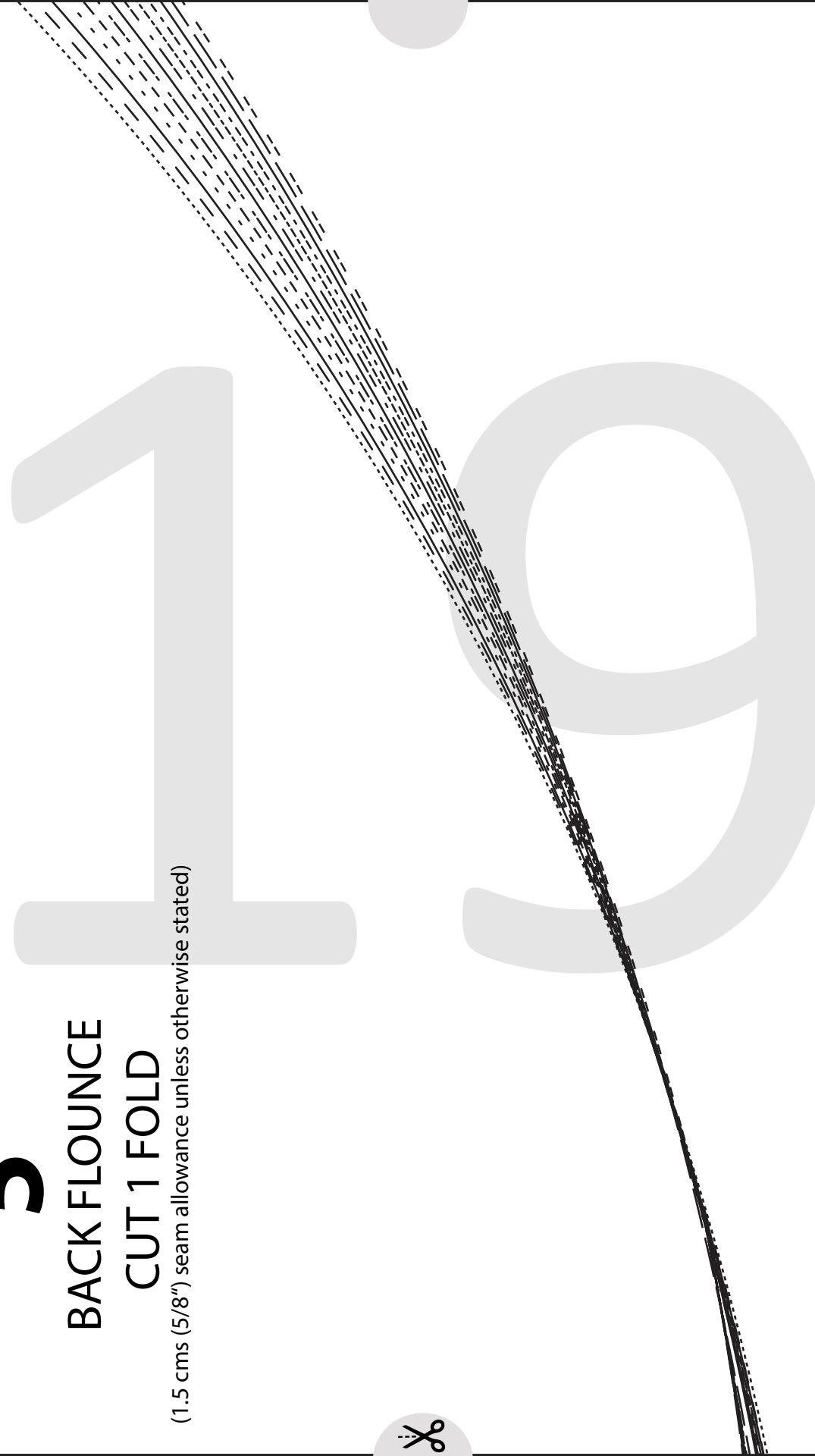
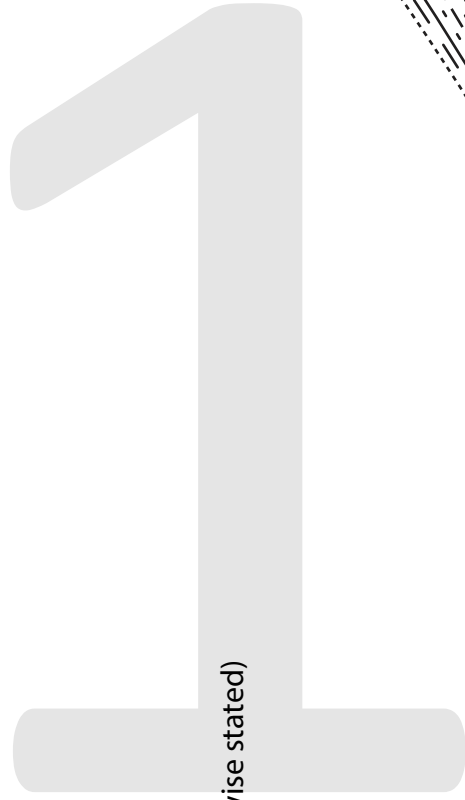

CUT HERE FOR 90 cms (35 1/2")
CUT HERE FOR 75 cms (29 1/2")

CUT HERE FOR 90 cms (35 1/2")
CUT HERE FOR 75 cms (29 1/2")

CUT HERE FOR 90 cms (35 1/2")
CUT HERE FOR 75 cms (29 1/2")

CUT HERE FOR 90 cms (35 1/2")
CUT HERE FOR 75 cms (29 1/2")

CUT HERE FOR 90 cms (35 1/2")
CUT HERE FOR 75 cms (29 1/2")

CUT HERE FOR 90 cms (35 1/2")

CUT HERE FOR 90 cms (35 1/2")

CUT HERE FOR 90 cms (35 1/2")

CUT HERE FOR 90 cms (35 1/2")

CUT HERE FOR 90 cms (35 1/2")

CUT HERE FOR 90 cms (35 1/2")

CUT HERE FOR 90 cms (35 1/2")

CUT HERE FOR 90 cms (35 1/2")

CUT HERE FOR 90 cms (35 1/2")



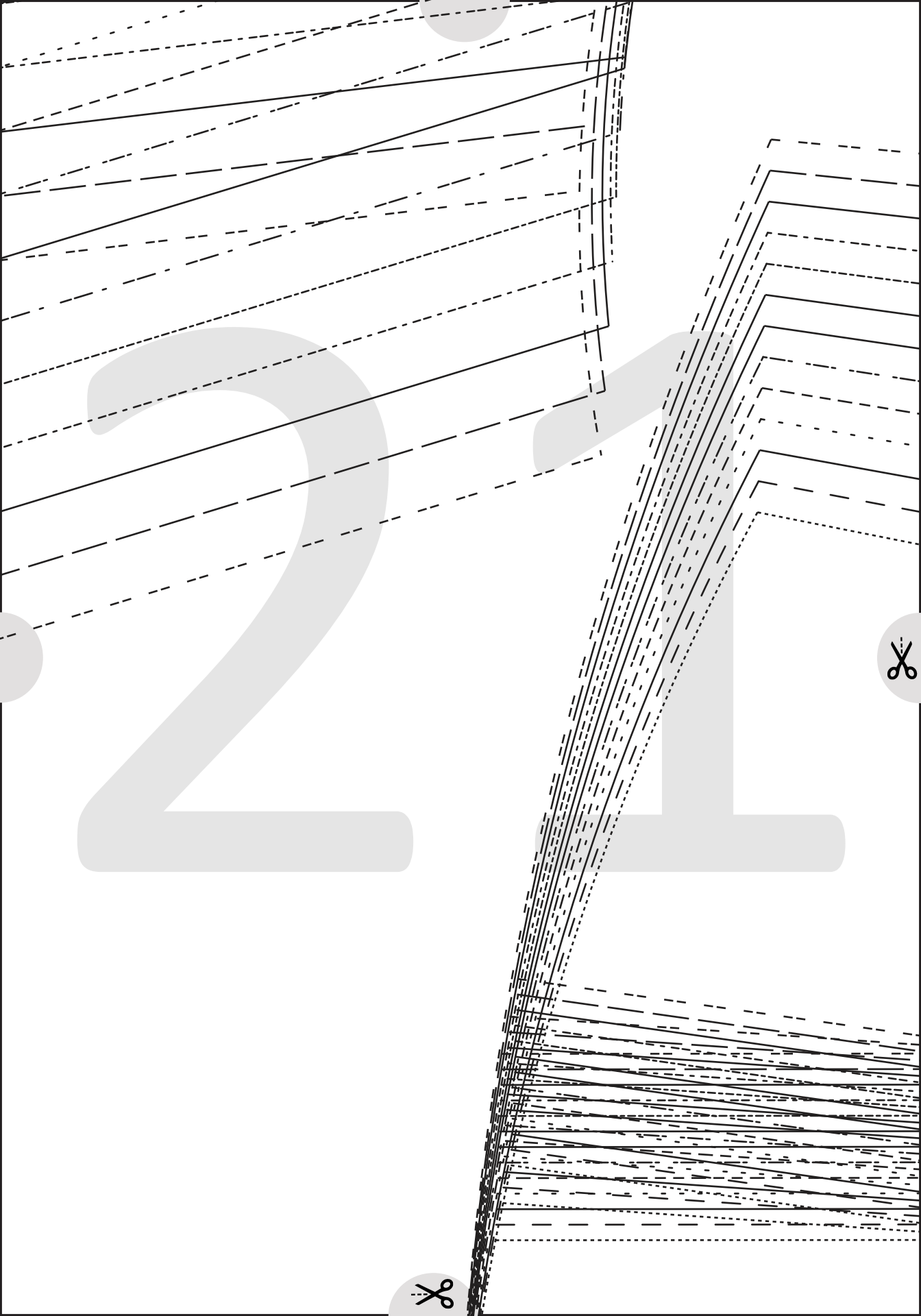

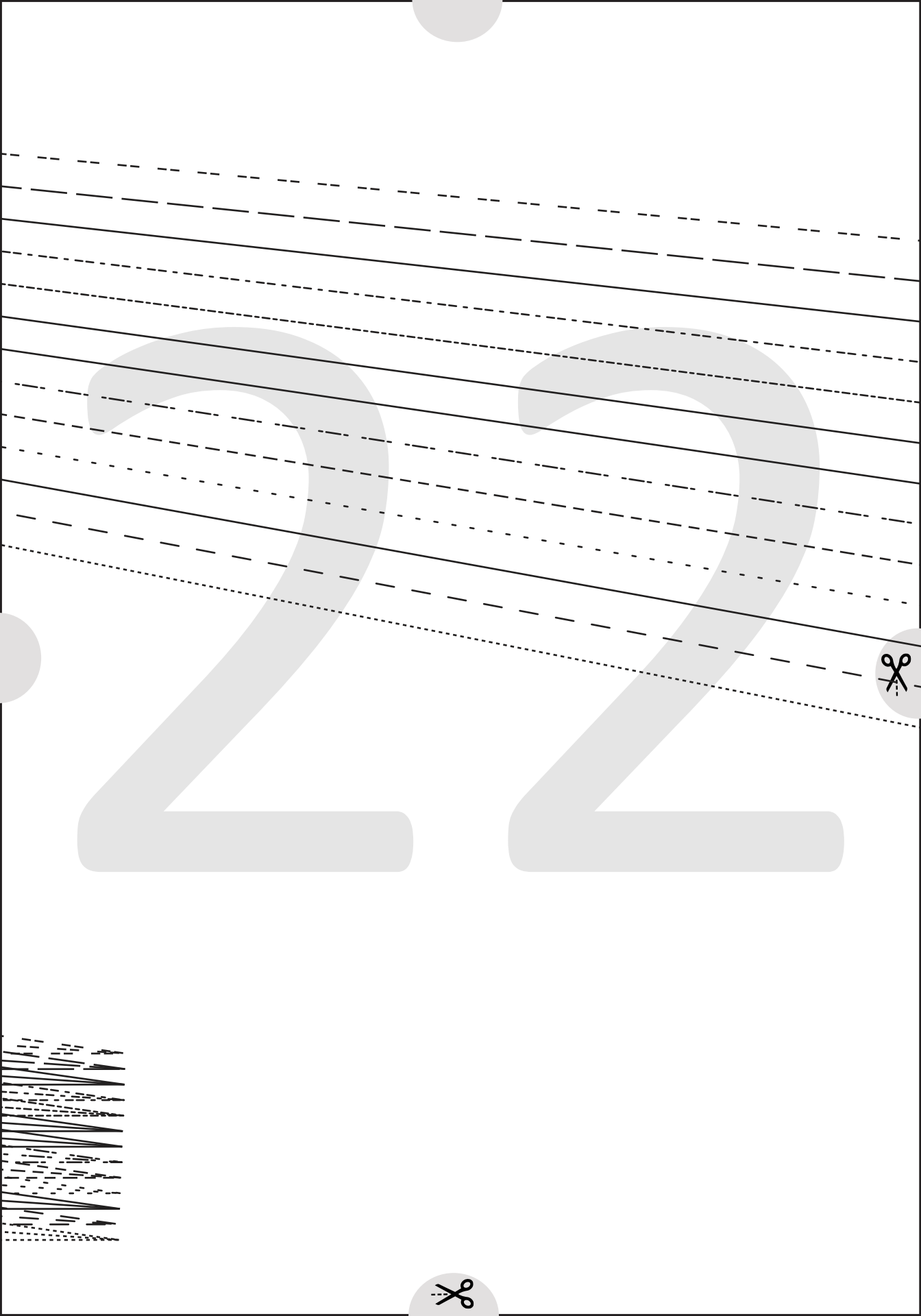

2

2

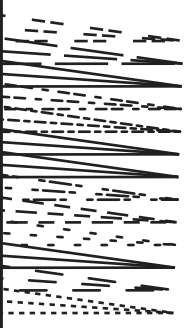

(1.5 Åm



23

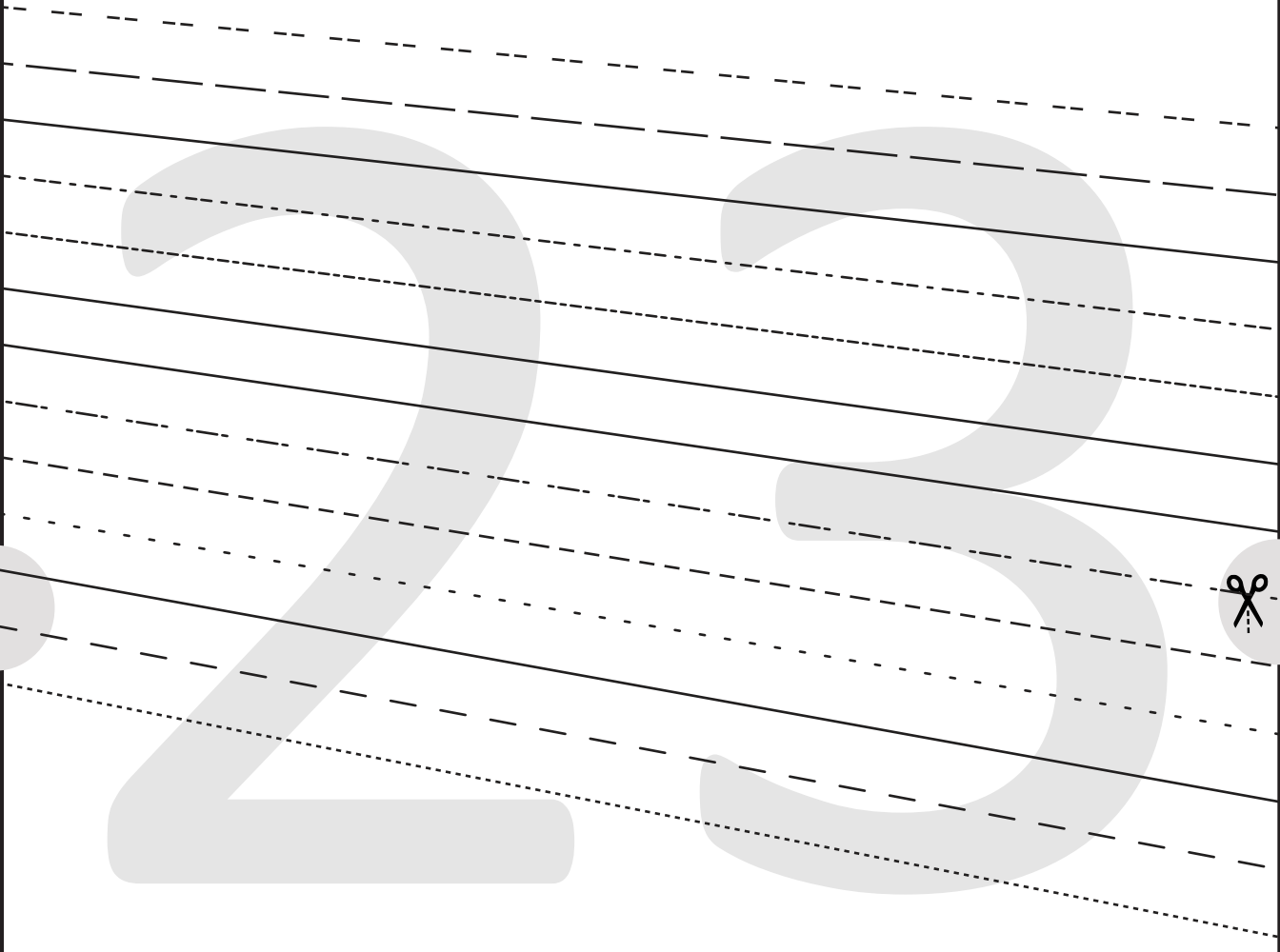

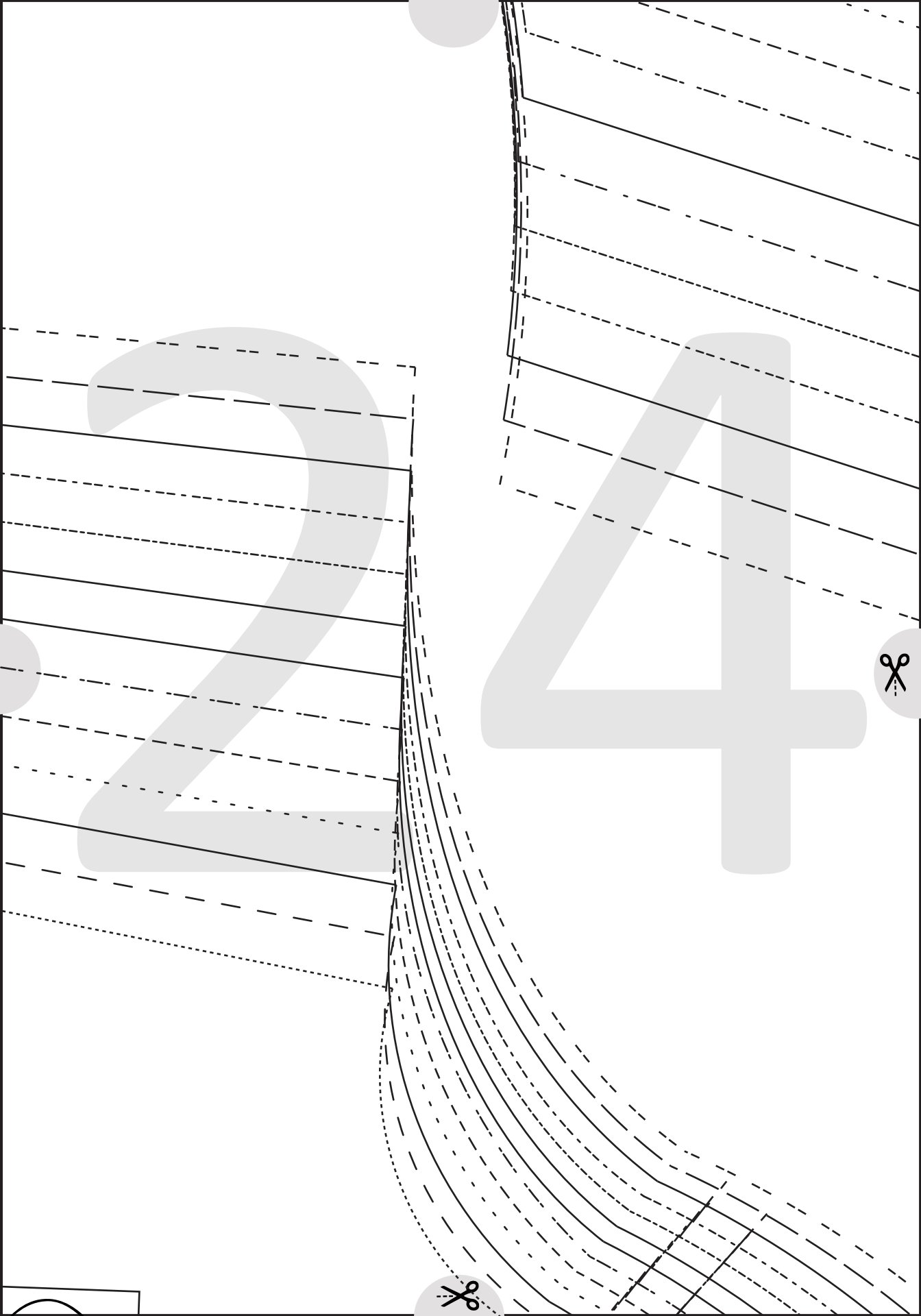

SIDE SEAM

SIDE SEAM

SIDE SEAM

SIDE SEAM

SIDE SEAM

SIDE SEAM

SIDE SEAM

SIDE SEAM

SIDE SEAM

SIDE SEAM

SIDE SEAM

SIDE SEAM

SIDE SEAM



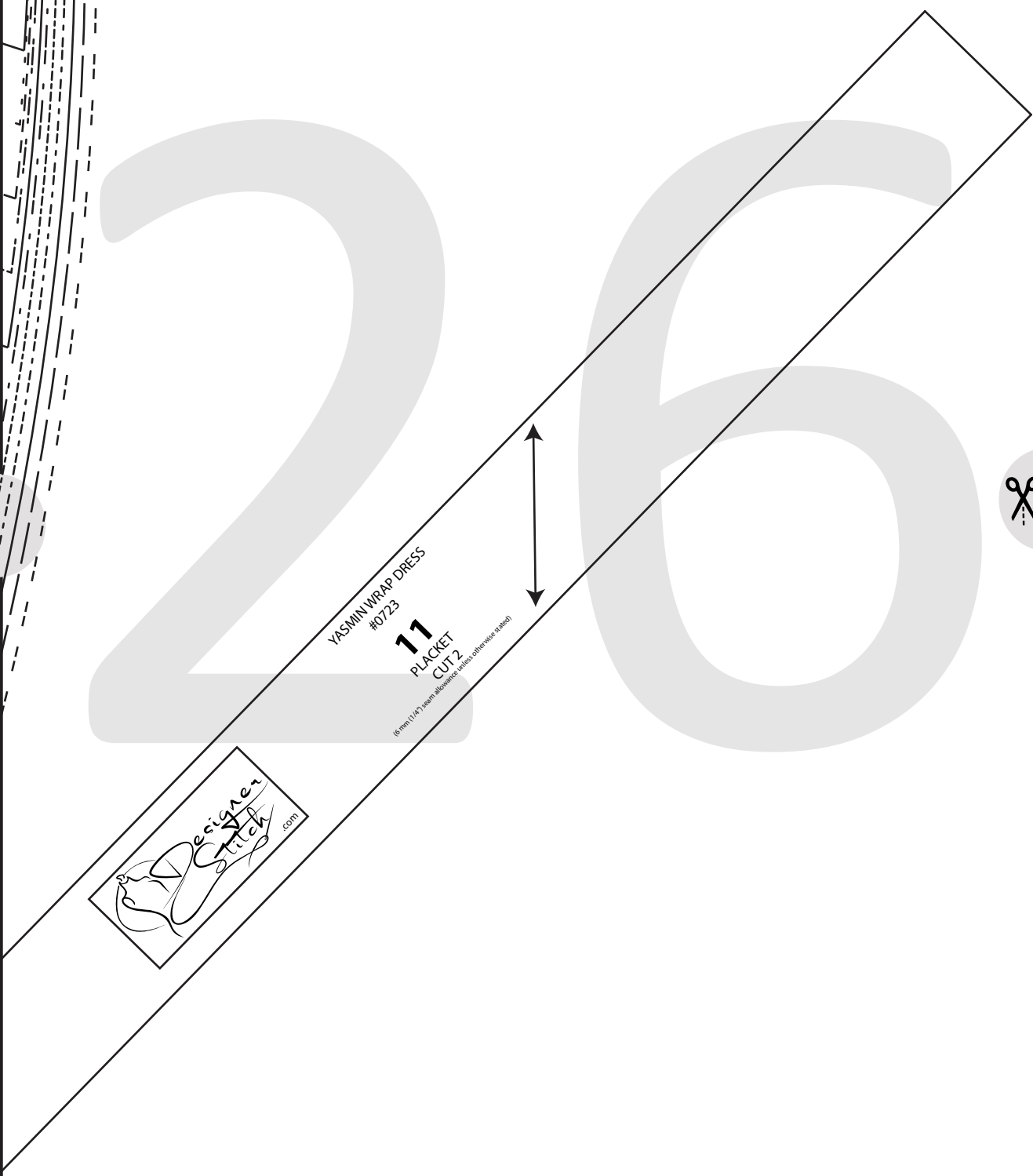
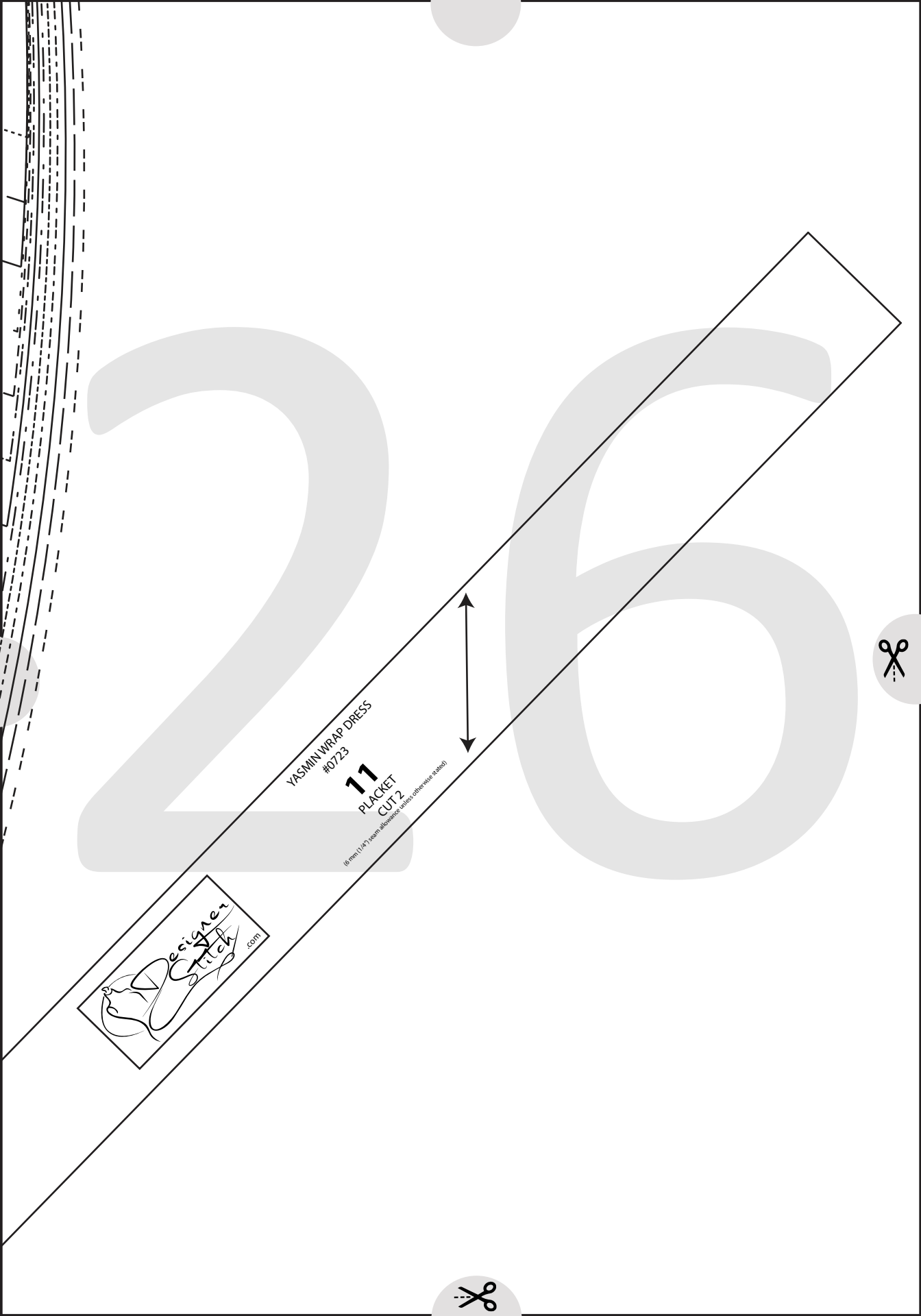

YASMIN WRAP DRESS
#0723

11
PLACKET
CUT 2

(6 mm (1/4") seam allowance unless otherwise noted)

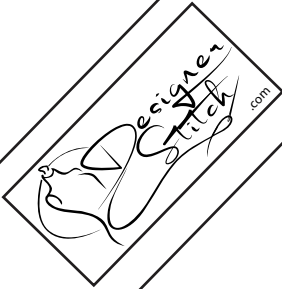

1 cm (3/8") SEAM ALLOWANCE



HERE FOR 7.5 cms (2 1/2")



28

CUT HERE FOR 55 cms (21 3/4")

CUT HERE FOR 60cms (23 1/2")



29

6mm (1/4") SEAM ALLOWANCE



30





YASMIN WRAP DRESS

#0723

9

PLACKET SLEEVE

CUT 2

s (5/8") seam allowance unless otherwise stated)



CUT



32

1 cms (3/8") SEAM ALLOWANCE

1 cms (3/8") SEAM ALLOWANCE



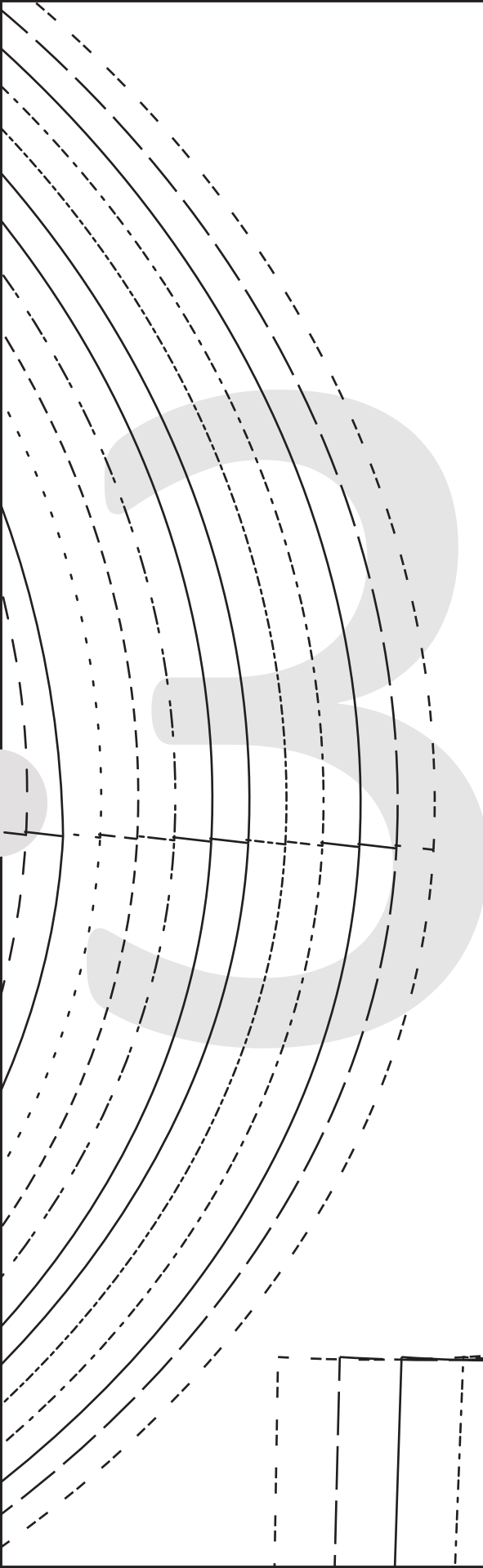
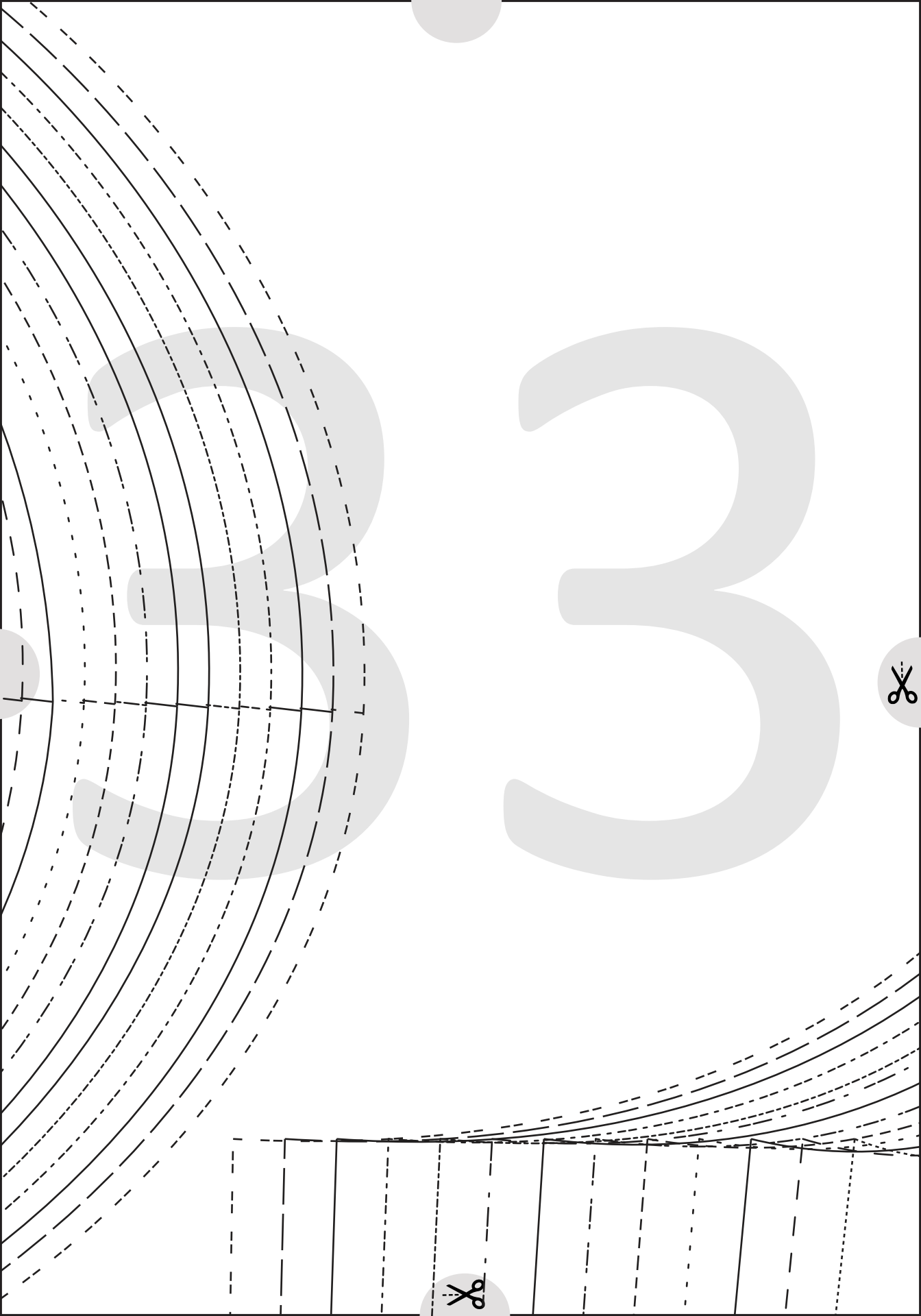

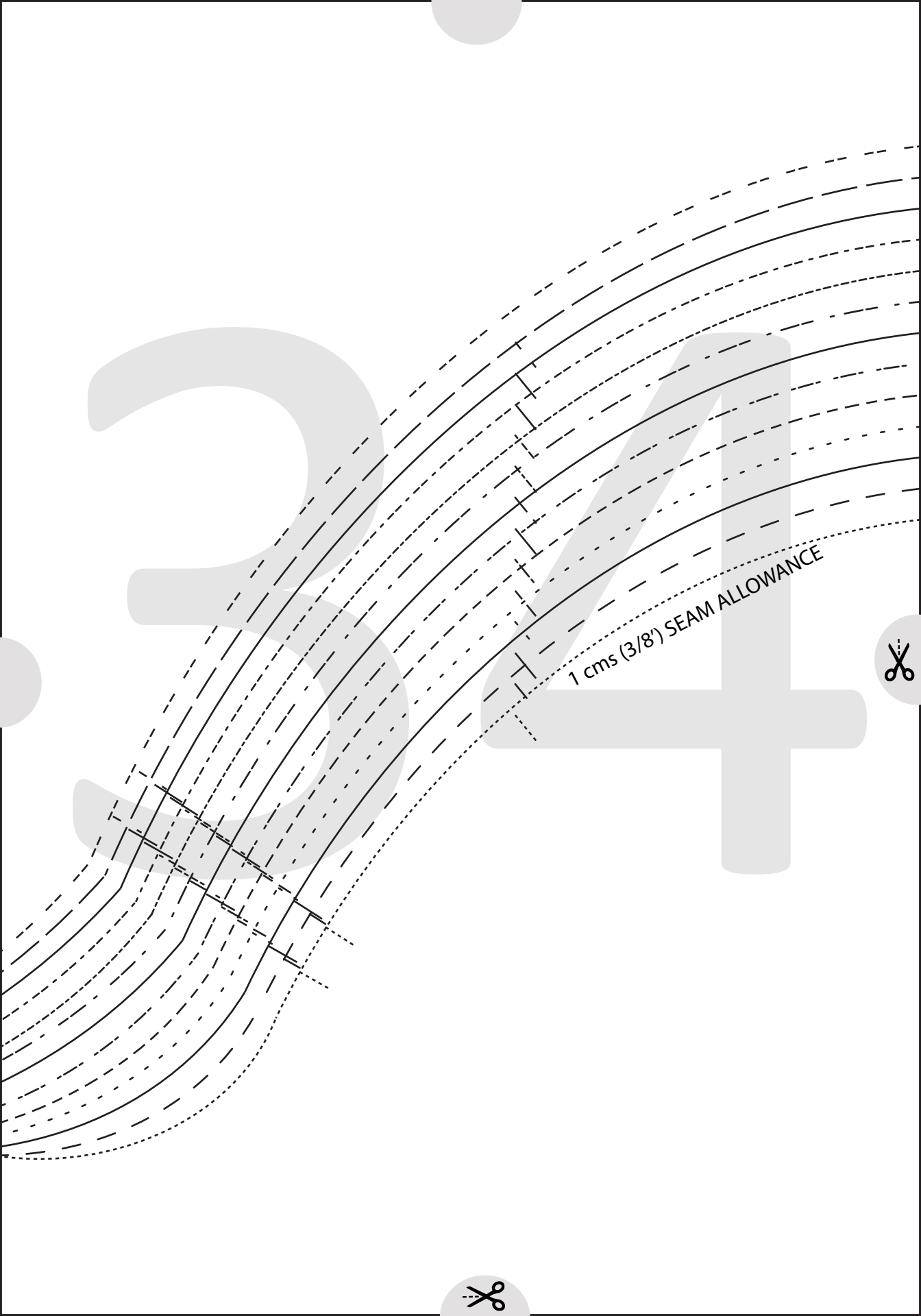

1 cms (3/8") SEAM ALLOWANCE



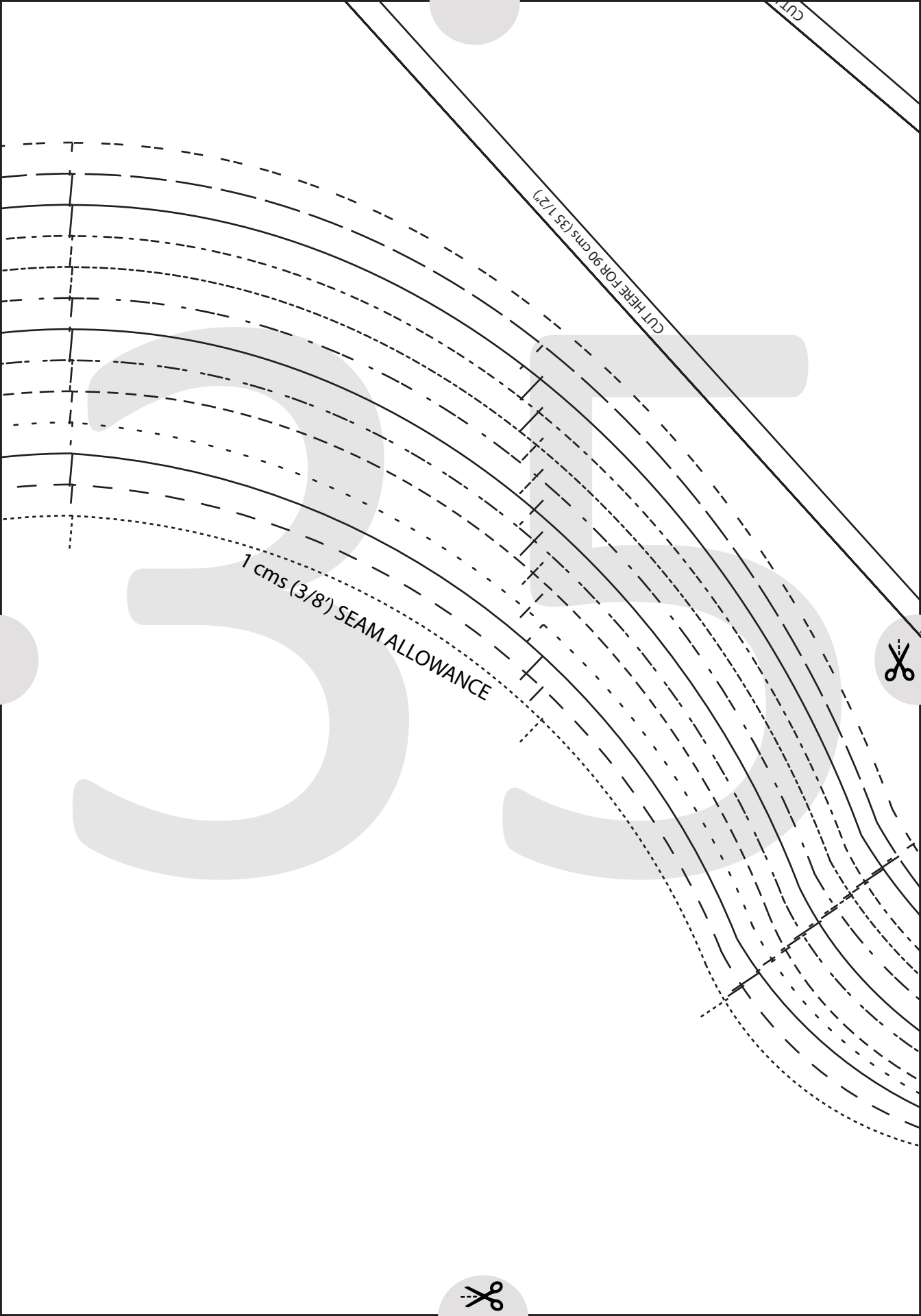

CUT

CUT HERE FOR 90 cms (35 1/2")

1 cms (3/8) SEAM ALLOWANCE



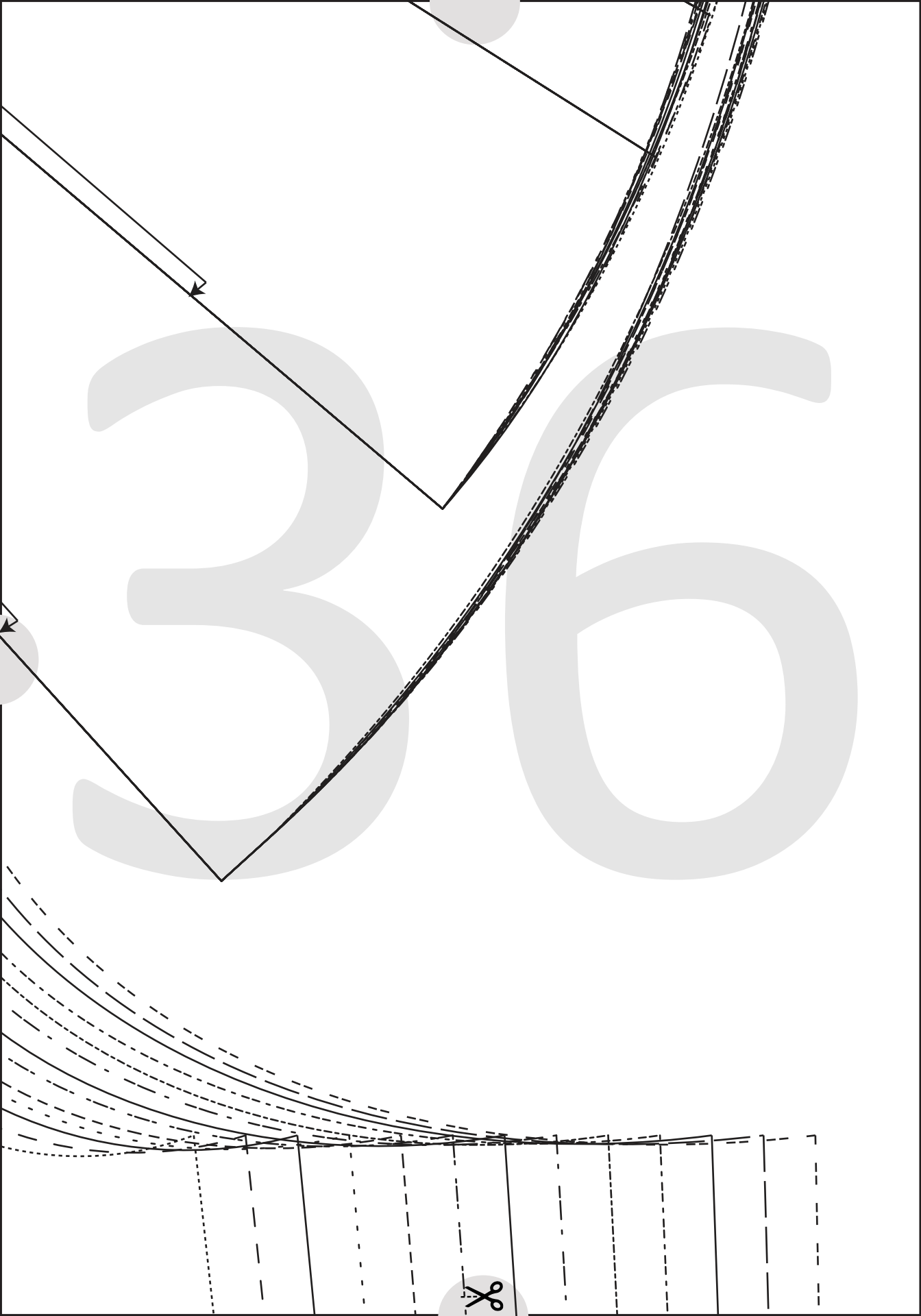

3 6

36

36



3

7



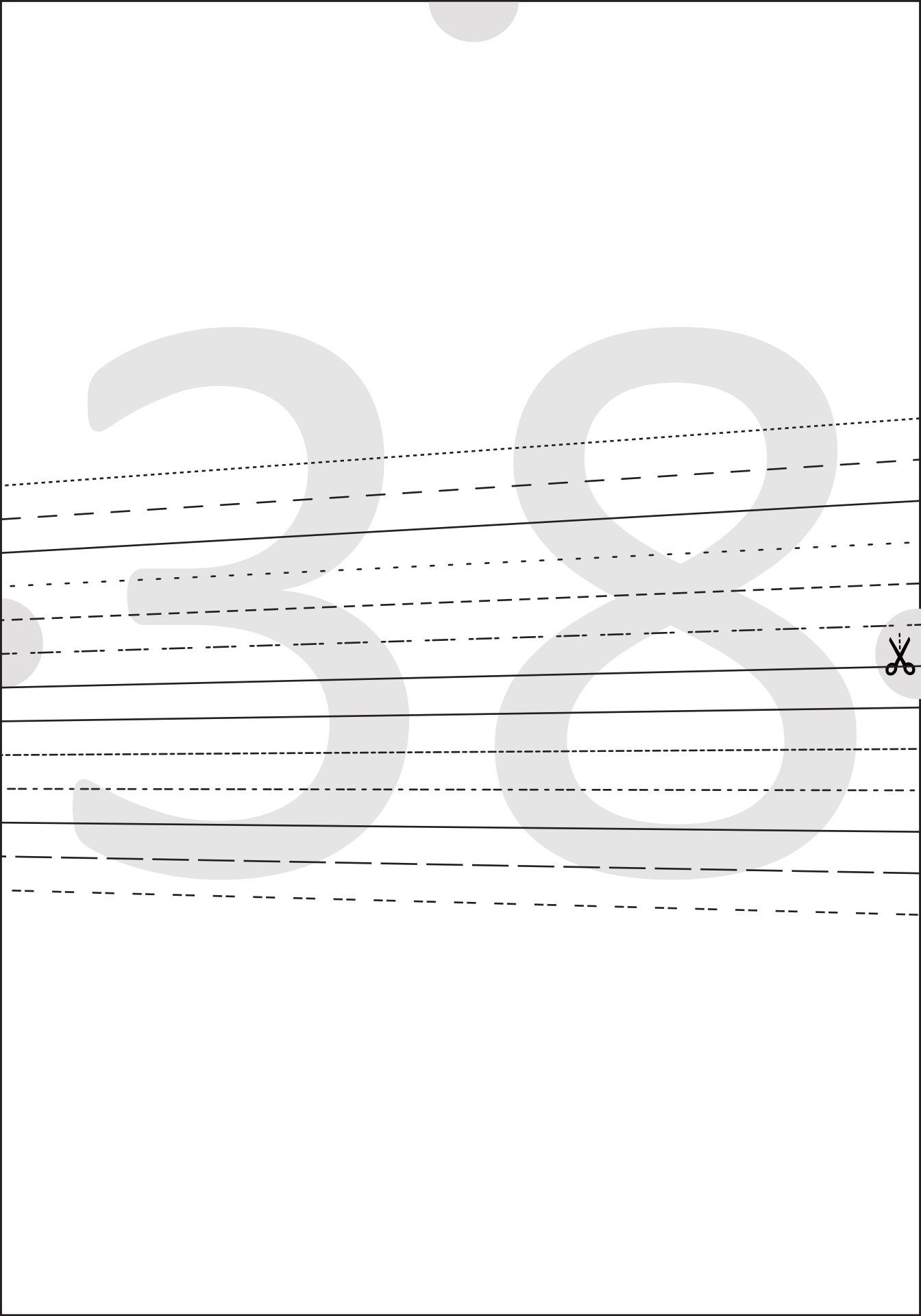

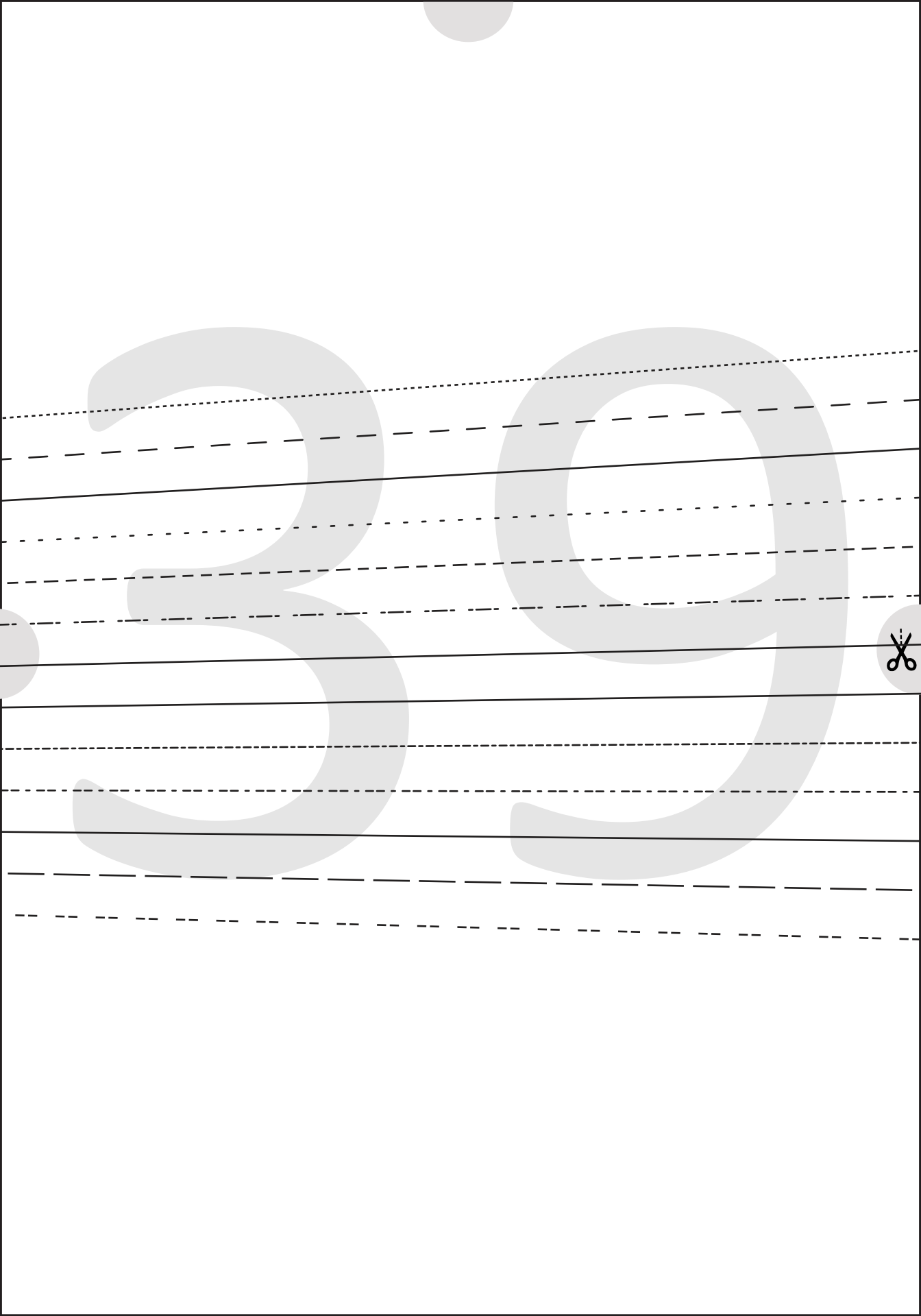

3

9



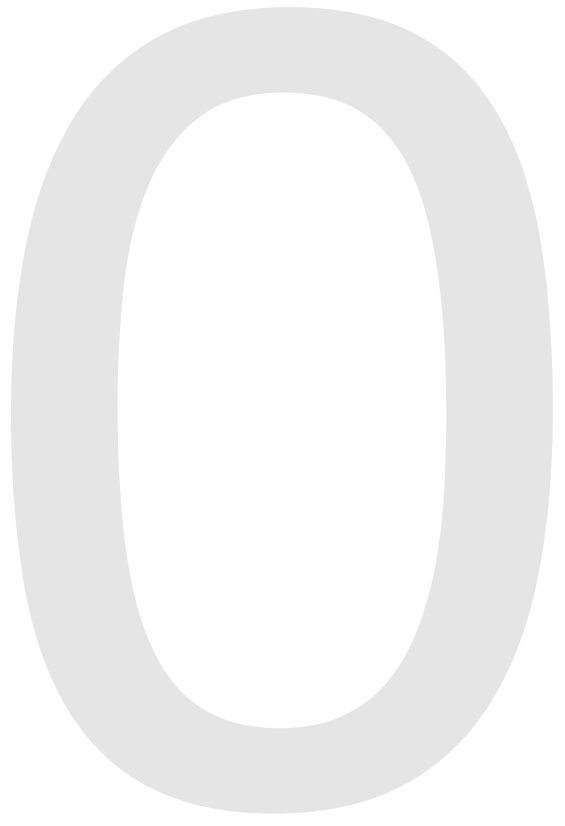
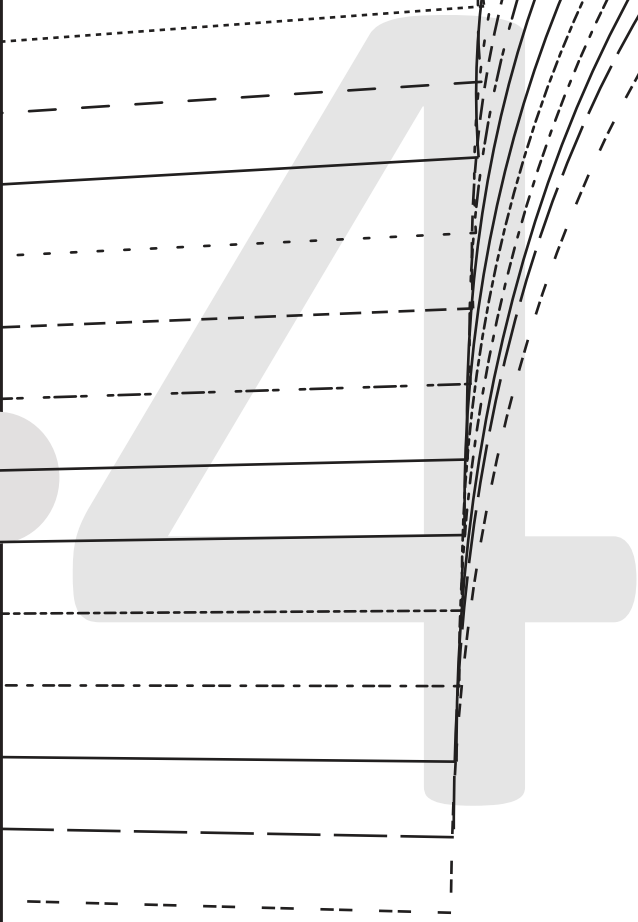
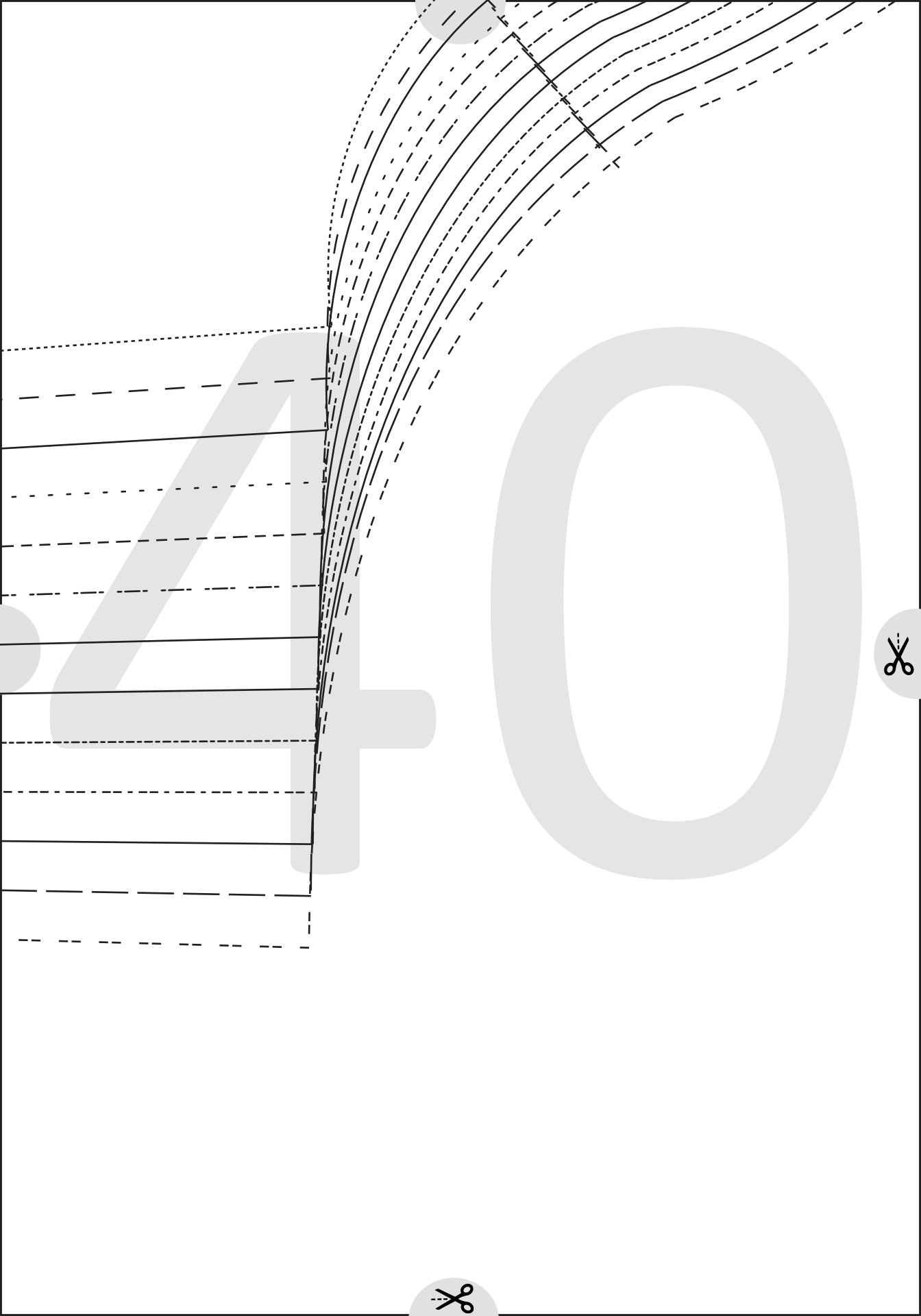

4

1



4

2





YASMIN WRAP DRESS

#0723

12

SHIRRED SLEEVE

CUT 2

(1.5 cms (5/8") seam allowance unless otherwise stated)

CUT HERE ABOVE ELBOW SLEEVE 2 cms (3/4") SEAM ALLOWANCE



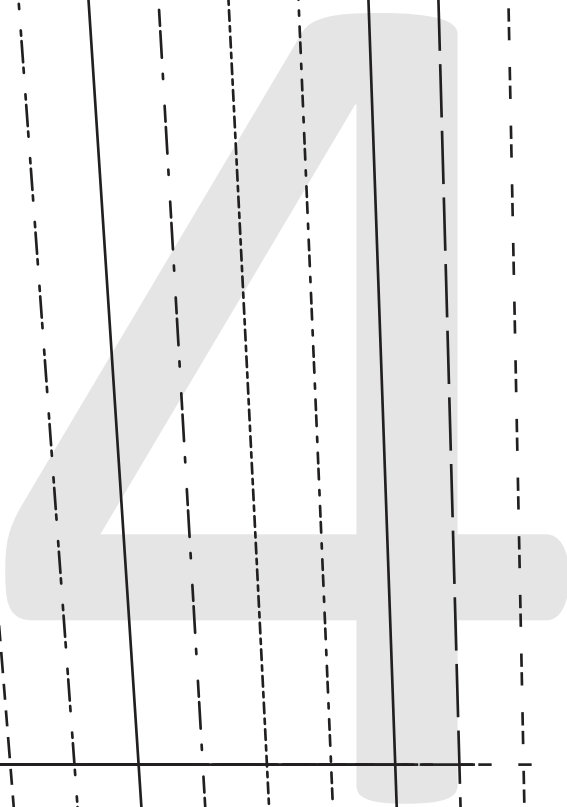
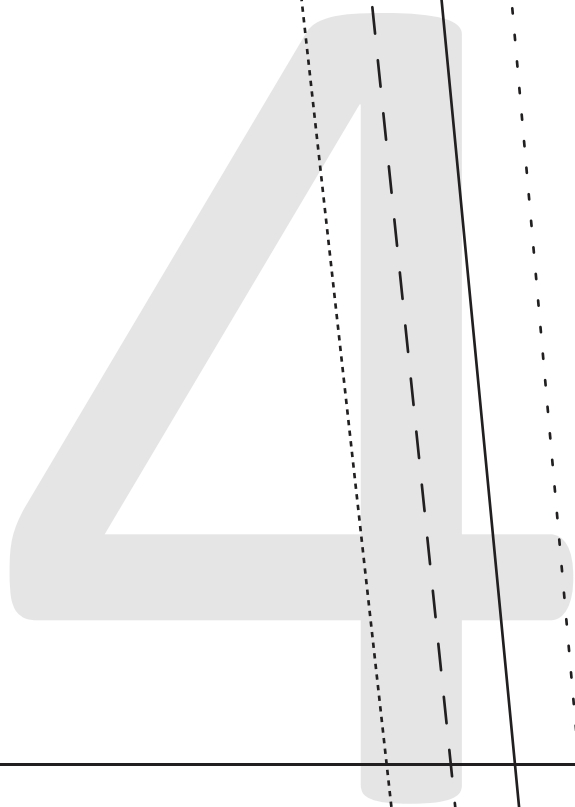



45



4

6





4

7



48



CUT HERE LONG SLEEVE

2 cms (3/4") SEAM ALLOWANCE

4

9