

PRINT TILING TEMPLATE GUIDE FOR SIZE SPECIFIC CHOICE  
 TRIMLESS PRINT AT HOME PATTERN

CUT HERE 60 cms (23 1/2") = 1.5 cms (5/8") HEM ALLOWANCE

CUT HERE 60 cms (23 1/2") = 1.5 cms (5/8") HEM ALLOWANCE

CUT HERE 60 cms (23 1/2") = 1.5 cms (5/8") HEM ALLOWANCE

CUT HERE 60 cms (23 1/2") = 1.5 cms (5/8") HEM ALLOWANCE

CUT HERE 60 cms (23 1/2") = 1.5 cms (5/8") HEM ALLOWANCE

CUT HERE 60 cms (23 1/2") = 1.5 cms (5/8") HEM ALLOWANCE

CUT HERE 75 cms (29 1/2") = 1.5 cms (5/8") HEM ALLOWANCE

CUT HERE 75 cms (29 1/2") = 1.5 cms (5/8") HEM ALLOWANCE

CUT HERE 75 cms (29 1/2") = 1.5 cms (5/8") HEM ALLOWANCE

CUT HERE 75 cms (29 1/2") = 1.5 cms (5/8") HEM ALLOWANCE

CUT HERE 75 cms (29 1/2") = 1.5 cms (5/8") HEM ALLOWANCE

CUT HERE 75 cms (29 1/2") = 1.5 cms (5/8") HEM ALLOWANCE

CUT HERE 75 cms (29 1/2") = 1.5 cms (5/8") HEM ALLOWANCE

CUT HERE 75 cms (29 1/2") = 1.5 cms (5/8") HEM ALLOWANCE

CUT HERE 75 cms (29 1/2") = 1.5 cms (5/8") HEM ALLOWANCE

CUT HERE 75 cms (29 1/2") = 1.5 cms (5/8") HEM ALLOWANCE

CUT HERE 75 cms (29 1/2") = 1.5 cms (5/8") HEM ALLOWANCE

CUT HERE 75 cms (29 1/2") = 1.5 cms (5/8") HEM ALLOWANCE

CUT HERE 75 cms (29 1/2") = 1.5 cms (5/8") HEM ALLOWANCE

CUT HERE 75 cms (29 1/2") = 1.5 cms (5/8") HEM ALLOWANCE

CUT HERE 75 cms (29 1/2") = 1.5 cms (5/8") HEM ALLOWANCE

CUT HERE 75 cms (29 1/2") = 1.5 cms (5/8") HEM ALLOWANCE

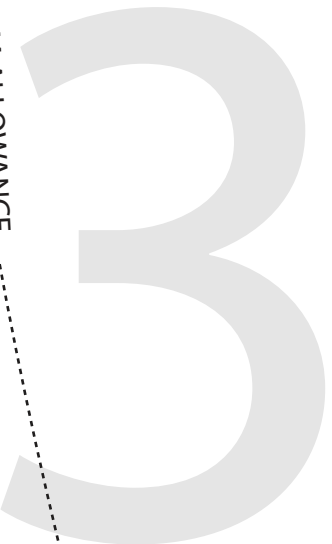

CUT HERE 60 cms (23 1/2") = 1.5 cms (5/8") HEM ALLOWANCE

CUT HERE 60 cms (23 1/2") = 1.5 cms (5/8") HEM ALLOWANCE

CUT HERE 60 cms (23 1/2") = 1.5 cms (5/8") HEM ALLOWANCE

CUT HERE 60 cms (23 1/2") = 1.5 cms (5/8") HEM ALLOWANCE

CUT HERE 60 cms (23 1/2") = 1.5 cms (5/8") HEM ALLOWANCE

CUT HERE 60 cms (23 1/2") = 1.5 cms (5/8") HEM ALLOWANCE

CUT HERE 60 cms (23 1/2") = 1.5 cms (5/8") HEM ALLOWANCE

CUT HERE 60 cms (23 1/2") = 1.5 cms (5/8") HEM ALLOWANCE

CUT HERE 60 cms (23 1/2") = 1.5 cms (5/8") HEM ALLOWANCE

# LUANA PARTY DRESS

#1123

# 23

CIRCULAR SKIRT

CUT 1 FOLD - FRONT

CUT 2 - BACK

(1.5 cms (5/8") seam allowance  
unless otherwise stated)



CENTRE BACK SEAM FOR ZIPPER INSERTION

CENTRE FRONT FOLD

1 cms (3/8") SEAM ALLOWANCE

5

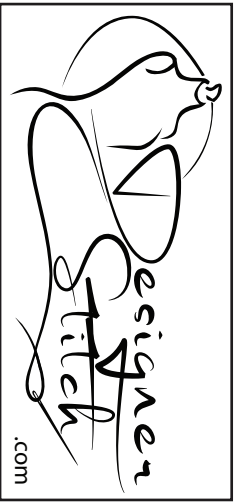

LUANA PARTY DRESS

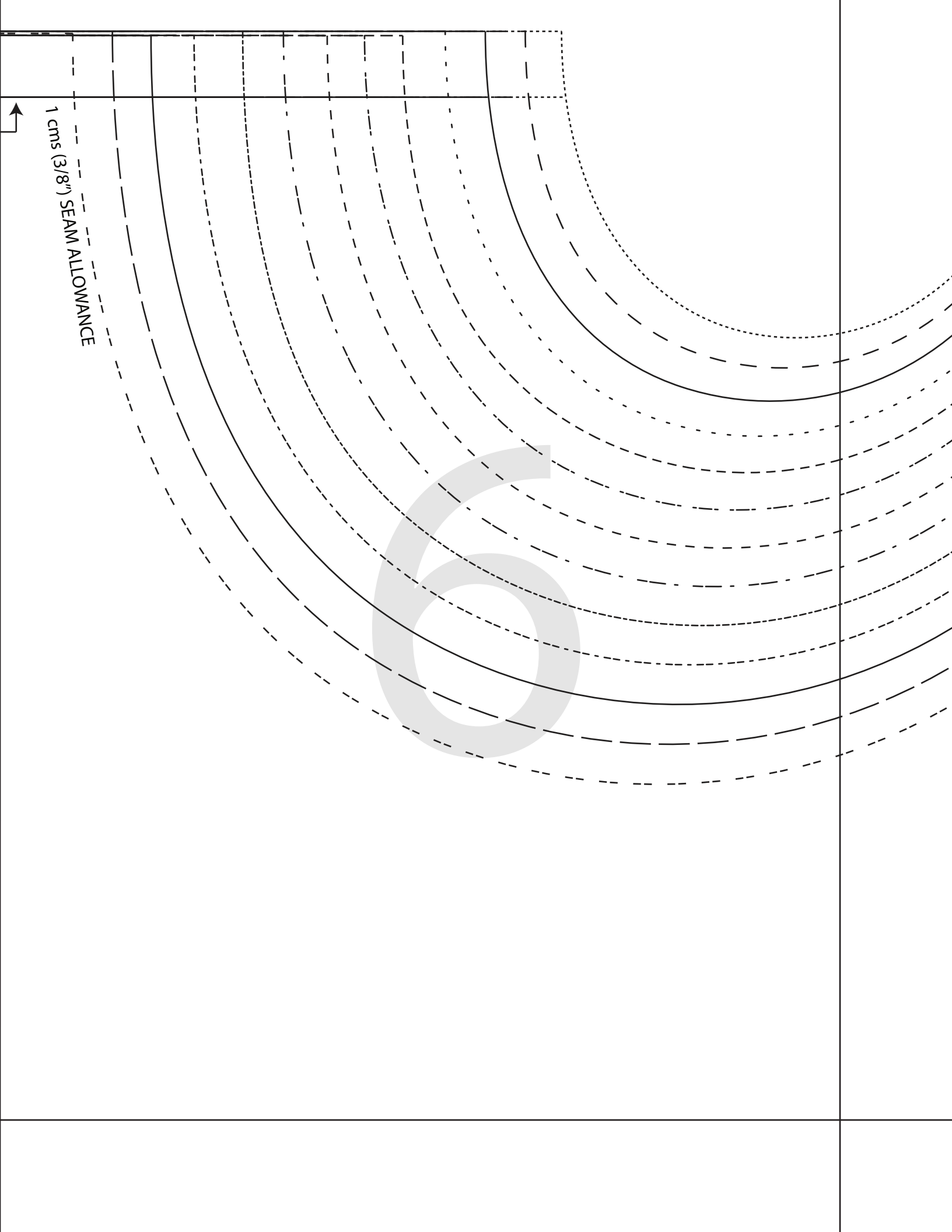

1 cms (3/8") SEAM ALLOWANCE

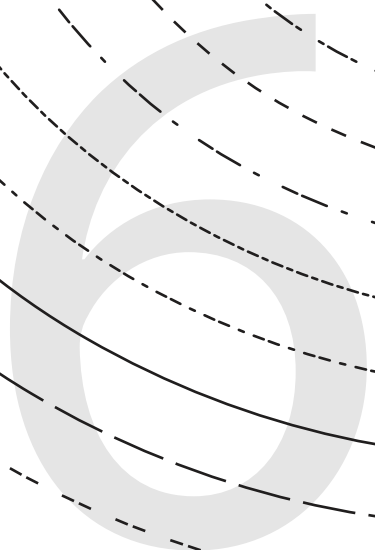

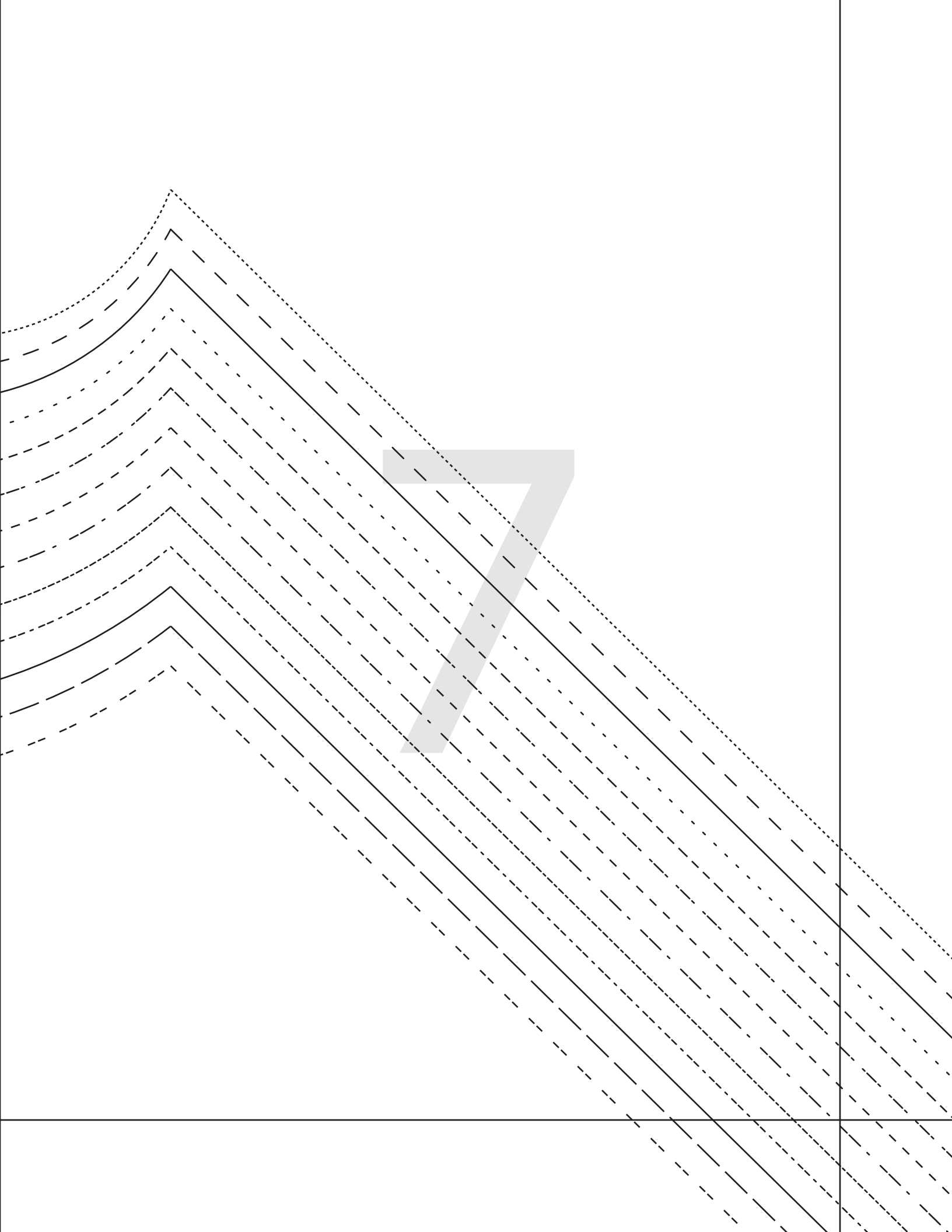



LUANA  
PARTY  
DRESS  
#1123

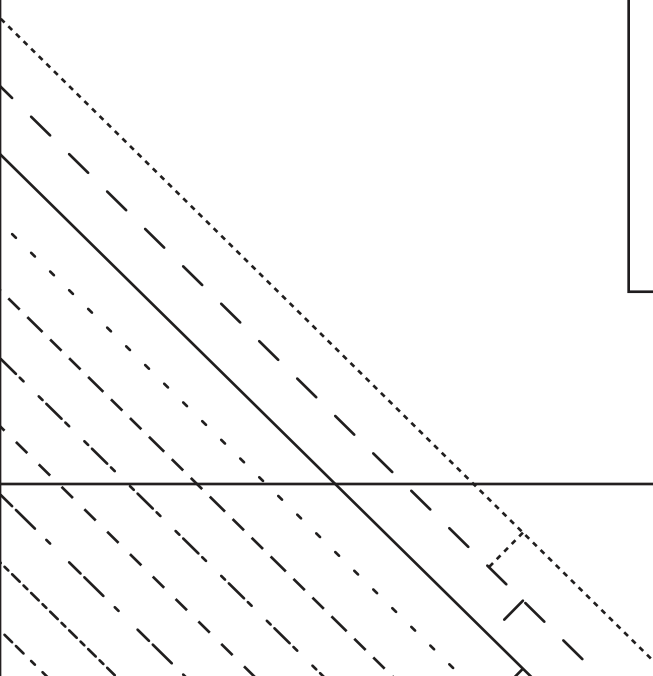
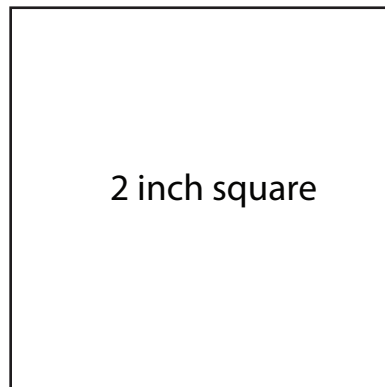
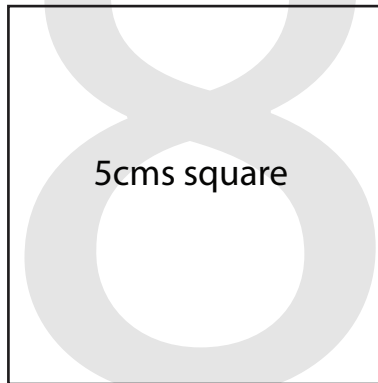



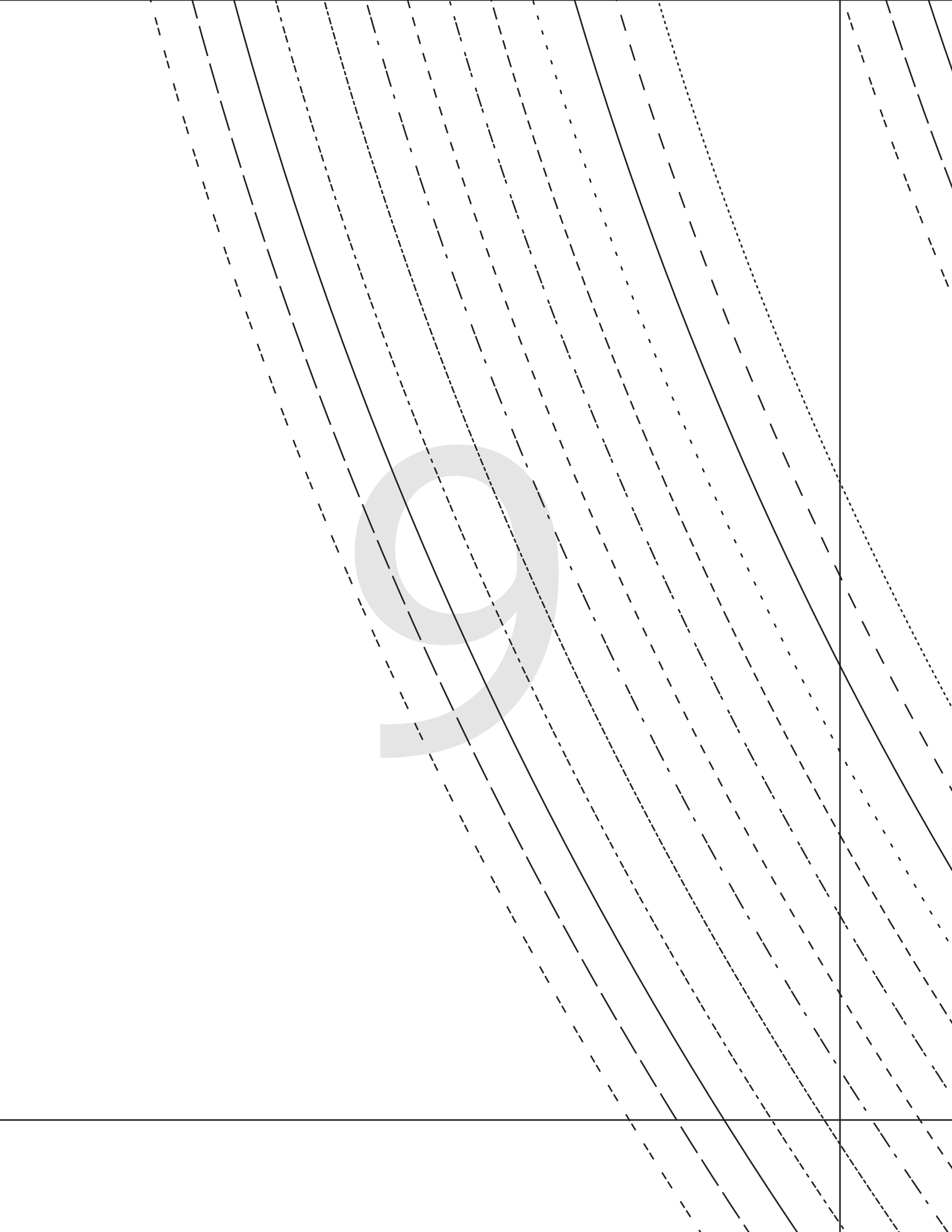

10

11

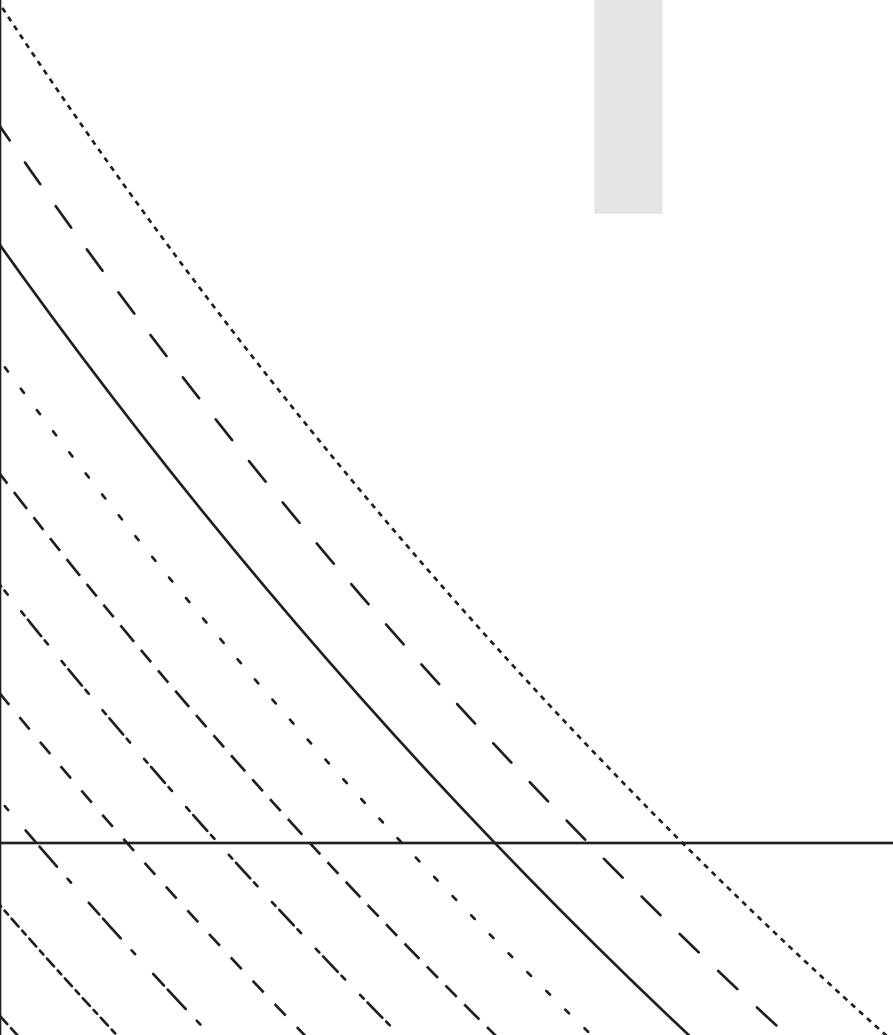

12

13

14

15

16

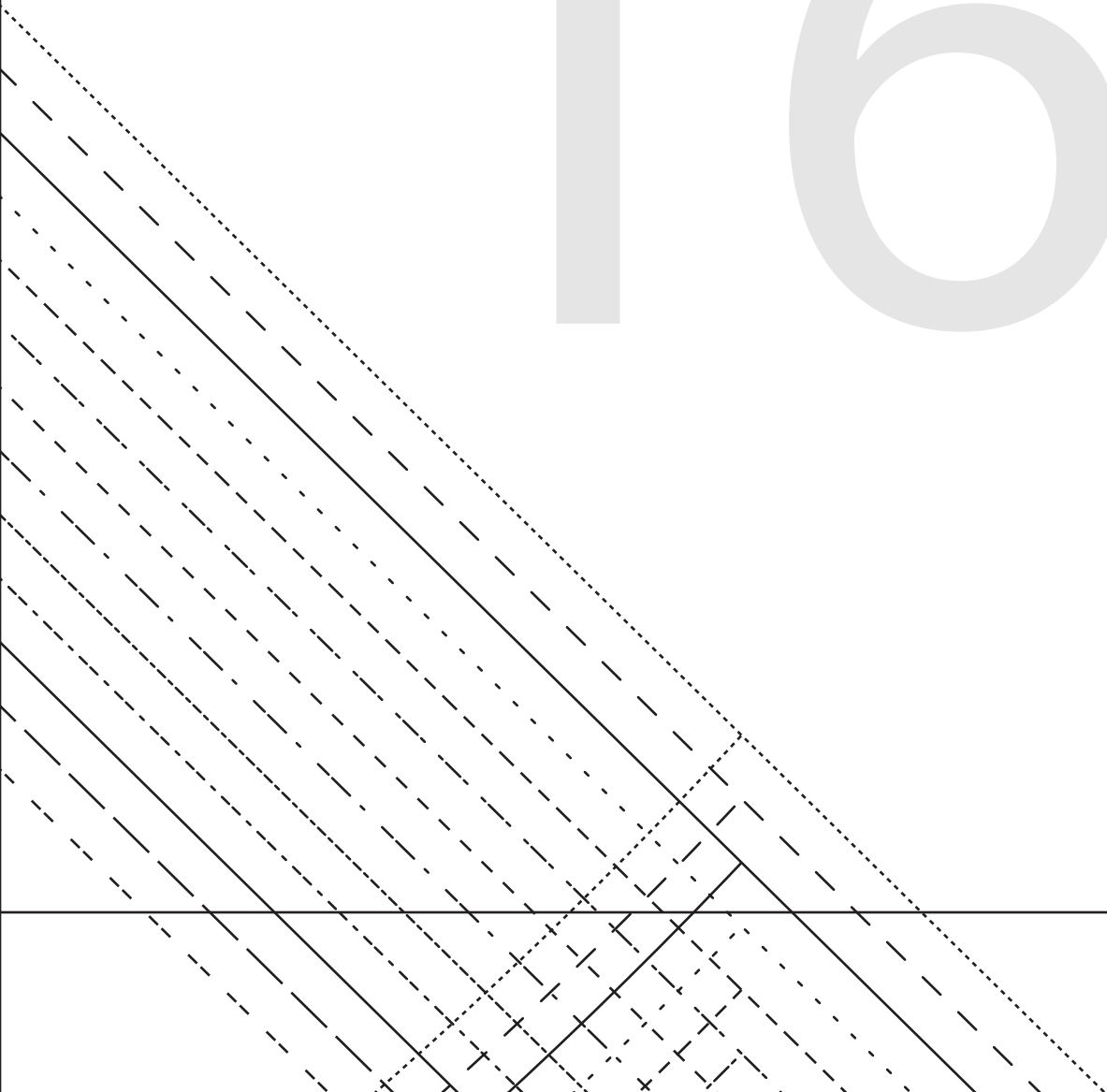



17

18

19

20

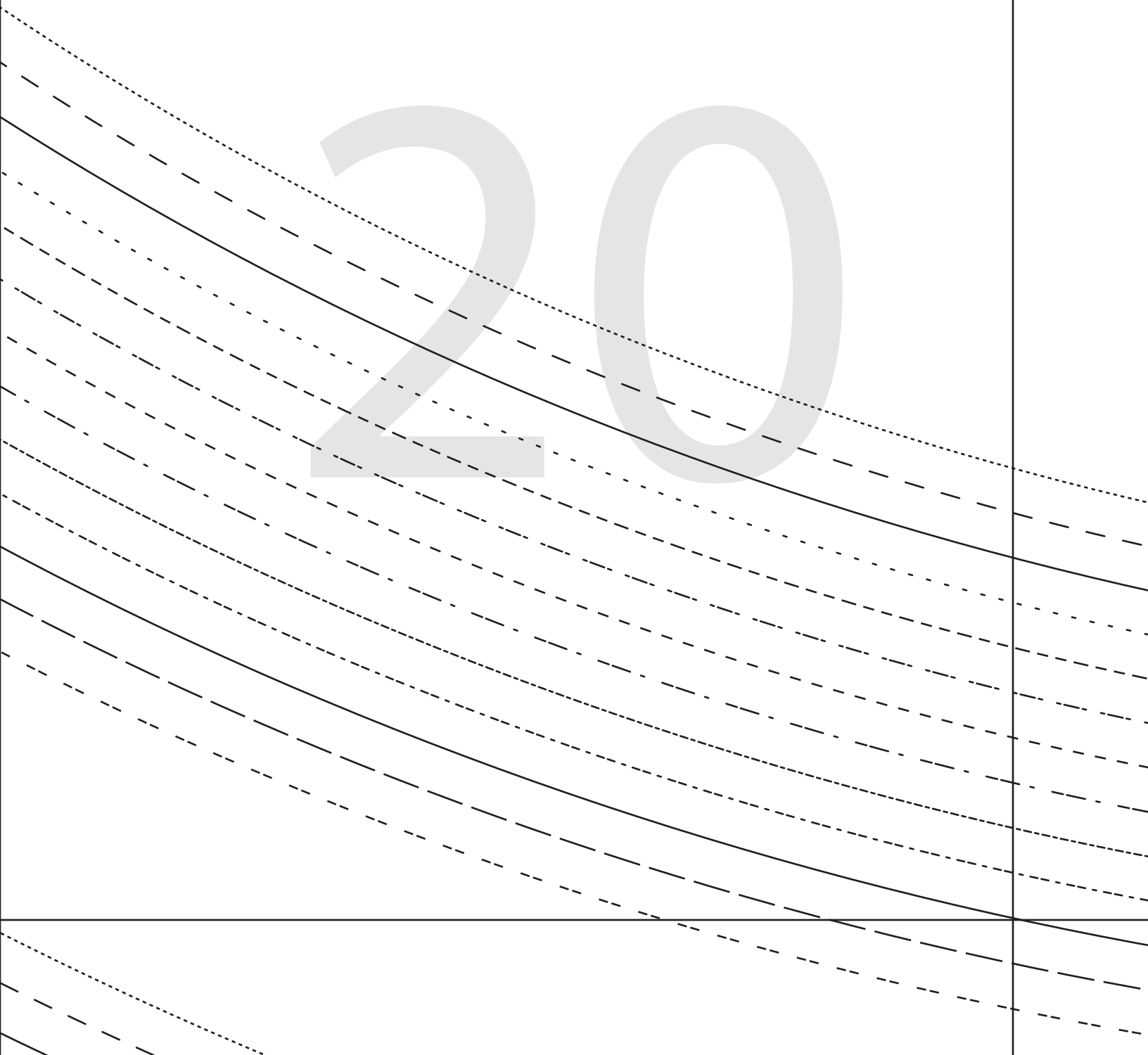

21

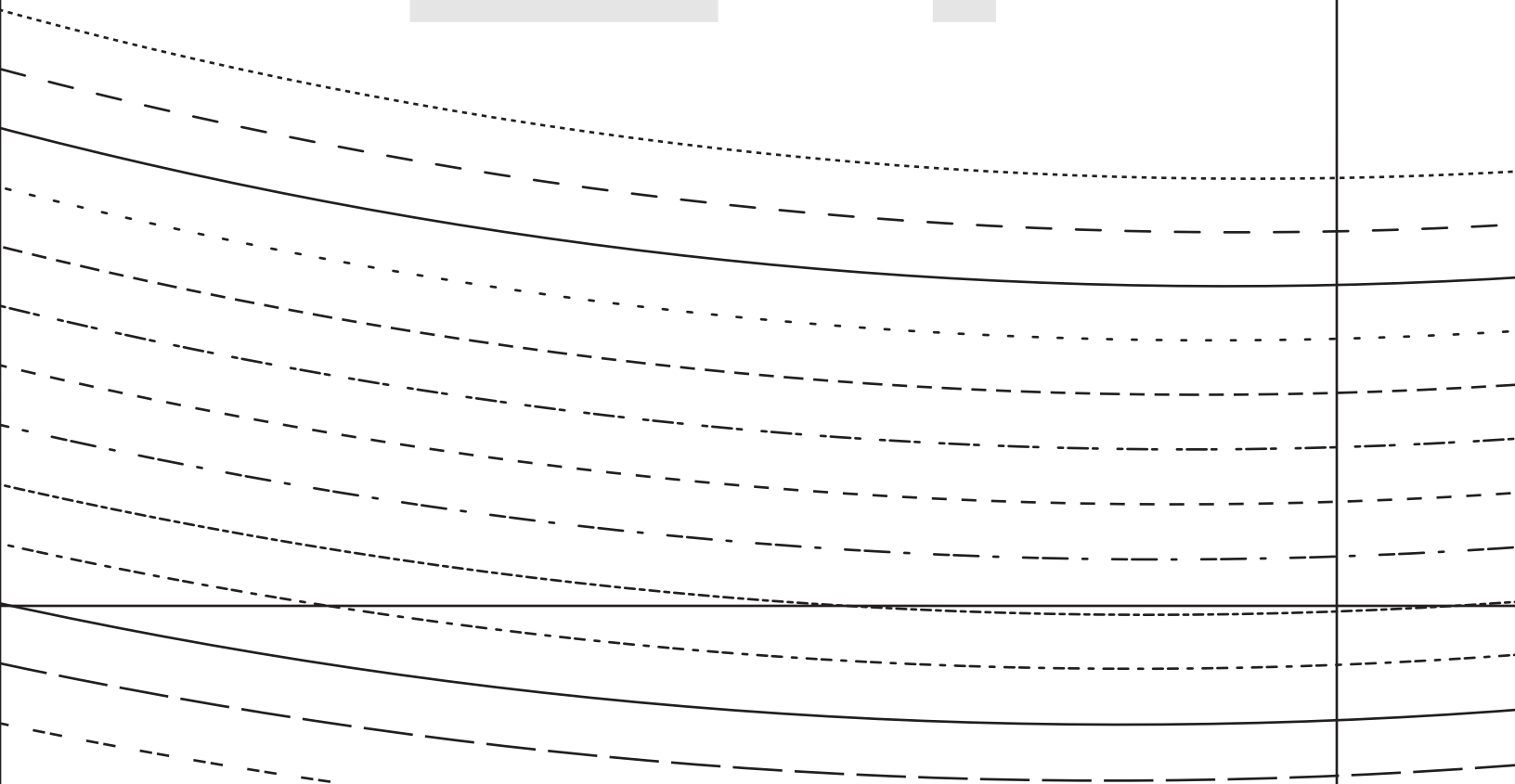

22

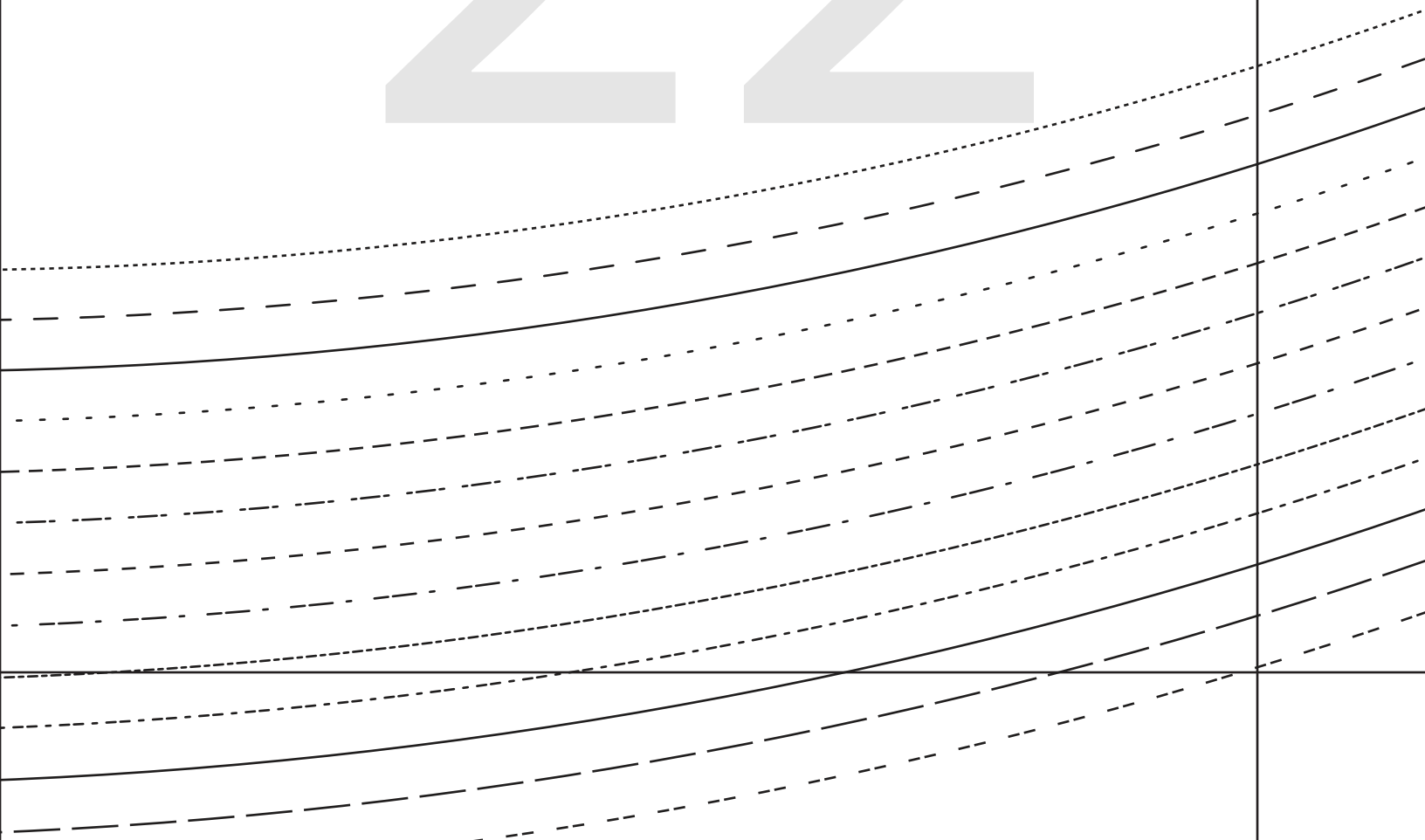

23

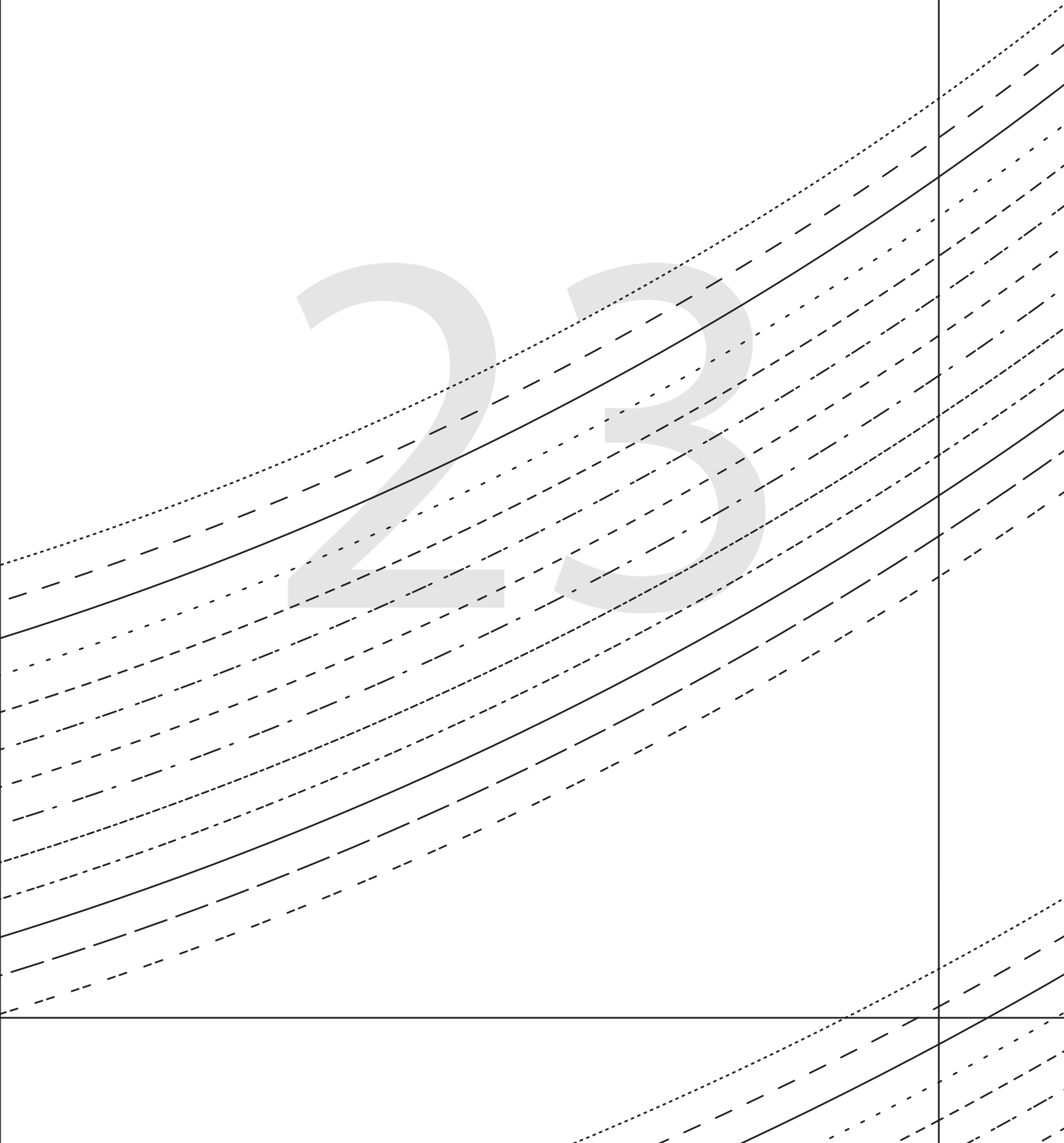

24



25

The background features a series of curved lines in the upper right quadrant, transitioning from a solid line to a dashed line to a dotted line. A thin black grid is present, with a vertical line on the right and a horizontal line at the bottom.

26

27

28

29

30

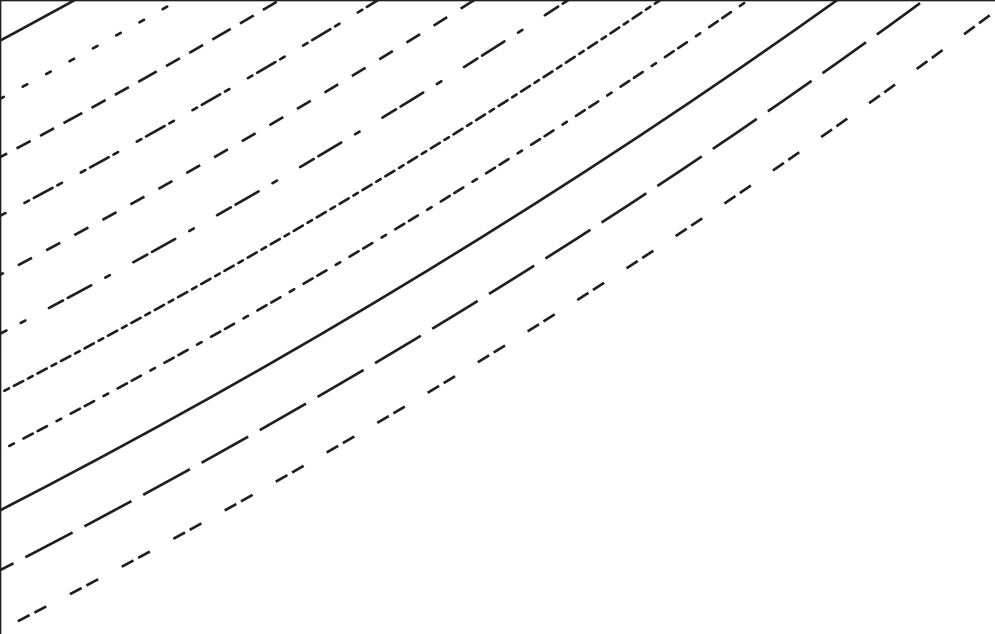

31